

20 Bedini-Bearden Years

**FREE ENERGY**



**GENERATION**

**Circuits & Schematics**

# FREE ENERGY GENERATION

---

## Circuits & Schematics

John Bedini and Tom Bearden

1984-2004



FREE ENERGY GENERATION

Circuits & Schematics

By John Bedini and T. E. Bearden

All rights reserved.

No part of this book may be reproduced in any form  
without the permission of Cheniere Press.

Copyright © 2006 by Cheniere Press

[www.cheniere.org](http://www.cheniere.org)

Second Edition 2006

First edition of Part I published originally in 1984 under the title  
Bedini's Free Energy Generator. Copyright 1984 © by John C. Bedini.

ISBN 0-9725146-8-6

First Edition, First Printing – October 2006

Printed in the United States of America

Energy From The Vacuum™ is a registered trademark.

**Fuck Rotchild**

**And his New World Order  
gang of jackals.**

**Let's ruin their satanic plans!**

*Editor's note:*

While filming John Bedini in his facilities in 2004 for the documentary series *Energy from the Vacuum*, John came up to me during a break and placed a grey booklet in my hand.

“Why don't you republish this?” he asked, in his typically understated way. And then, as an afterthought he added, “And why don't you also include the patent that Tom Bearden and I just filed on extracting ‘radiant energy’ from the vacuum, and also include my website?”

I looked at the booklet, and was stunned to see that this was the legendary *Bedini's Free Energy Generator* monograph from 1984, long since unavailable, which included the circuits and parts specifications to build an actual device that would extract *free* energy from the vacuum into usable form.

This booklet was the genesis for Jim Watson's 800 pound generator that produced 8 Kw, and that was demonstrated at the first International Tesla Conference in Colorado Springs in 1984 (Jim Watson and his family then disappeared).

So here it is again for all you experimenters that have been clamoring for the “how to” as opposed to the “why.” And the provisional patent application regarding the extraction of radiant energy, written twenty years later, is the culmination of the journey that Tom Bearden and John Bedini have traveled together since the publication of that original booklet.

The Provisional Patent Application (PPA) is a 97-page technical and operational exposé of unparalleled scope and magnificence about a subject in which John is universally acknowledged as the master—harnessing radiant (negative and/or precursor) energy. Circuits, diagrams, explanations—the works.

I called Tom Bearden and told him about John Bedini's fantastically generous offer of placing all this proprietary information into the public domain. “If it's fine with John, it's fine with me,” said Tom.

So here it is. The real secrets of negative energy for all to understand and hopefully experiment with. The website, another cornucopia, will have to wait for another day. But all readers are encouraged to visit it.

Enjoy.

A.J. (Tony) Craddock

Director

Cheniere Media/ The Tom Bearden Website

May, 2006



## Table of Contents

THEN .....	1
<i>DEDICATION</i> .....	3
<i>FOREWORD</i> .....	5
<i>INTRODUCTION</i> .....	11
<i>BASIC CONCEPTS</i> .....	12
<i>THE CONTROL CIRCUIT</i> .....	17
<i>THE ENERGIZER</i> .....	22
NOW.....	35
<i>Document Setup and Figures</i> .....	37
<i>Section 1: Background Information</i> .....	51
1.0 Introduction.....	51
1.1. On Radiant Energy—Its Nature and Novel Characteristics .....	55
1.2. The Source Charge and Its Associated Fields and Potentials.....	73
1.3. Some Electromagnetics and Physics Background.....	78
1.4. Conclusions .....	88
<i>Section 2: Field, Summary and Objects</i> .....	89
2.0. Introduction.....	89
2.1. Field of the Invention .....	89
2.2. Summary of the Invention .....	89
2.3. Objects of the Invention.....	94
<i>Section 3: Functioning of the Invention</i> .....	103
3.0. Introduction.....	103
3.1. Brief Description of the Drawings Including Recapitulation.....	103
3.2. Detailed Description of the Invention .....	105
3.2.2. Inductive Coupled Oscillator and Diode Bridge .....	107
3.3. Variation of The Radiant Charger Using an SCR .....	112
3.4. Monopole Motor Powered by Radiant Energy Charger .....	116
3.5. Using Earth Cells with the Potential Switch and a Transistor.....	117
3.6. Embodiment with an Inverted Potential Switch .....	117
<i>Section 4: Advantages</i> .....	119
<i>Section 5: Other Advantages</i> .....	125
<i>Section 6: Remarks on Potential Claims</i> .....	131
Photo Section .....	137



FREE ENERGY GENERATION

---

References ..... 167

Table of Figures ..... 181



# FREE ENERGY GENERATION

---

FREE ENERGY GENERATION

---

THEN

**BEDINI'S FREE ENERGY GENERATOR**

by

John C. Bedini

## FREE ENERGY GENERATION

---

DEDICATION

To my Aunt Dorothy, and my wife, Rhonda Bedini. Without their support and encouragement, this agonizing effort would not have been possible.

# FREE ENERGY GENERATION

---

## FREE ENERGY GENERATION

---

### FOREWORD

John Bedini has a prototype free energy motor.

Imagine having a small D.C. electrical motor sitting on your laboratory bench powered by a common 12-volt battery. Imagine starting with a fully charged battery and connecting it to the motor with no other power input. Obviously, the motor is going to run off the battery, but by conventional thinking it will stop when the battery runs down.

Impossible, you say. Not at all. That's precisely what John Bedini has done and the motor is running now in his workshop.

It isn't running by the conventional wisdom of electrical physics. It isn't running by the conventional rules of electric motors and generators, but it is running.

And it isn't something complex. It's pretty simple, once one gets the hang of the basic idea.

It's running off the principles of electromagnetics that Nikola Tesla discovered shortly before 1900 in his Colorado Springs experiments. It's running off the fact that empty vacuum - pure "emptiness," so to speak - is filled with rivers and oceans of seething energy, just as Nikola Tesla pointed out.

It's running off the fact that vacuum space-time itself is nothing but pure massless charge. That is, vacuum has a very high electrostatic scalar potential -



it is greatly stressed. To usefully tap the enormous locked-in energy of that stress, all one has to do is crack it sharply and tap the vacuum oscillations that result. The best way to do that is to hit something resonant that is imbedded in the vacuum, then tap the resonant stress of the ringing of the vacuum itself.

In other words, we can ring something at its resonant frequency and, if that something is imbedded in the vacuum, we can tap off the resonance in vacuum stress, without tapping energy directly from the embedded system we rang into oscillation. So what we really need is something that is deeply imbedded in the vacuum, that is, something that can translate "vacuum" movement to "mass" movement.

Well, all charged particles and ions are already imbedded in the vacuum by their charged fluxes, so stressed oscillations - that is, vacuum oscillations - can be converted into normal energy of mass movement by charged particles or ions, if the system of charged particles or ions is made to resonate in phase with our tapping "potential." For our purpose, let's use a system of ions.

First we will need a big accumulator to hold a lot of the charged ions in the system that we wish to shock into oscillation. We need something that has a big capacitance and also contains a lot of ions.

An ordinary battery filled with electrolyte fits the bill nicely. While it's not commonly known, ordinary lead-acid storage batteries have a resonant ionic fre-

quency, usually in the range of from 1-6 MHz. All we have to do is shock oscillate the ions in the electrolyte at their resonant frequency and time our "trigger" potential and "siphon" current correctly. Then if we keep adding potential to trigger the system, we can get all that "potential" to translate into "free electrical energy."

Look at it this way. Conventionally "electrostatic scalar potential" is composed of work or energy per coulomb of charged particle mass. So if we add potential alone, without the mass flow, to a system of oscillating charged particles, we add "physical energy" in the entire charged particle system. In other words, the "potential" we add is converted directly into "ordinary energy" by the imbedded ions in the system. And if we are clever we don't have to furnish any pushing energy to move pure potential around.

(For proof that this is possible, see Bearden's *Toward a New Electromagnetics; Part IV; Vectors and Mechanisms Clarified*; Tesla Book Co., 1983<sup>1</sup>, slide 19, page 43, and the accompanying write-up, pages 10-11. Also see Y. Aharonov and V. Bohm, "Significance of Electromagnetic Potentials in the Quantum Theory", *Physical Review, Second Series*, Vol. 115, No. 3, Aug. 1, 1959, pp.485-491. On page 490 you will find that it's possible to have a field-free region of space, and still have the potential determine the physical properties of the system.)

---

<sup>1</sup> Available from The Tom Bearden website, [www.cheniery.org](http://www.cheniery.org)

Now this "free energy resonant coupling" can be done in a simple, cheap system. You don't need big cyclotrons and huge laboratories to do it; you can do it with ordinary D.C. motors, batteries, controllers and trigger circuits.

And that's exactly what John Bedini has done. It's real. It works. It's running now on John's laboratory bench in prototype form.

But that's not all. John also is a humanitarian. He's as concerned as I am for that little old widow lady at the end of the lane, stretching her meager Social Security check as far as she can, shivering in the cold winter and not daring to turn up her furnace because she can't afford the frightful utility bills.

That's simply got to change and John Bedini may well be the fellow who changes it. By openly releasing his work in this paper, he is providing enough information for all the tinkerers and independent inventors around the world to have at it. If he can get a thousand of them to duplicate his device, it simply can't be suppressed as so many others have been.

So here it is. John has deliberately written his paper for the tinkerer and experimenter, not for the scientist. You must be careful, for the device is a little tricky to adjust in and synchronize all the resonances. You'll have to fiddle with it, but it will work. Keep at it.

Also, we warn you not to play with this unless you know what you are doing. The resonating battery elec-

## FREE ENERGY GENERATION

---

trolyte produces hydrogen, and if you hit it too hard with a voltage spike you can get an electrical spark inside the battery. If that happens, the battery will explode, so don't mess with it unless you are qualified and use the utmost caution.

But it does work. So all you experimenters and pioneers, now's your chance. Have at it. Build it. Tinker with it. Fiddle it into resonant operation. Then let's build this thing in quantity, sell it widely, and get those home utilities down to where we can all afford them - including the shivering little old lady at the end of the lane.

And when we do, let's give John Bedini, and inventors like him, the credit and appreciation they so richly deserve.

Tom Bearden

April 13, 1984

FREE ENERGY GENERATION

---

INTRODUCTION

One day a boy who plays with motors and generators gets a brilliant idea. He reasons with himself: "If I hook the motor to the generator via the same shaft, the generator should run the motor and vice versa." He soon discovers that many things are against him, so he devises better schemes and finds the same things again. (Summary of a *Time-Life* article on energy.)

However you may view this article, it does not count, because the principles on which our machine works are completely different. At this point, I will make reference to Tom Bearden's *Toward a New Electromagnetics; Part 4: Vectors and Mechanisms Clarified*, Tesla Book Co., 1983<sup>2</sup>. If you plan to build this machine, it is a must that you get Tom Bearden's paper. You will find on pages 20, 21 and 22 the description of a simple free energy motor. Also, you will find a block diagram on page 53, slide 40. Understanding the material in this paper is a must, or you may not succeed in building this simple free energy generator.

Special thanks is given to Tom Bearden for discussing a multitude of questions. Without him, this would not have been possible. Any errors made in this paper are my own and not the fault of others.

I must also state that neither John Bedini nor the publisher takes any responsibility for misuse of the

---

<sup>2</sup> Available from The Tom Bearden website, [www.cheniere.org](http://www.cheniere.org).

information in the present paper due to bad hookups, misuse of the battery or faulty mechanical workmanship.

### BASIC CONCEPTS

For some time man has been looking for different ways to generate electricity. He has used water power, steam power, nuclear power and solar power. Recent papers written by Tom Bearden make a free energy generator possible. Tom Bearden, rather than patent his devices, chose to share them with people who had open ears. I myself have had numerous conversations with Tom Bearden. I found Tom to be one of the most reasonable men I have ever dealt with in this energy field. Most others would tell you stories of great machines they had, but would never present the truth with circuit diagrams or a look at the machine in question. Tom, on the other hand, clearly presents his ideas and discloses the concepts by means of which they work.

The facts I am about to present to you about free energy were never put into textbooks, only portions were. The textbooks have grounded people in conventional theory and made things very complicated. What I am about to explain is very simple; anyone can understand this theory and anyone who understands what he is doing can build this device.

I have been grounded in conventional theory for some eleven years. I have always tried to study the simplicity of electrical circuits, but my mind wouldn't allow

this because of my orthodox training. In any event, I had to change the way I was looking at things. I started to wonder, why do we need to have things so complicated? The truth of the matter is, we have been taught to consume or waste energy at every turn in our lives, so we jump into our cars, turn on lights, etc. In other words, we have been conditioned to waste energy and fuels lavishly, not realizing that someday someone will sky-rocket our energy bills to a point where we will not be able to pay for these fuels. Everything will come to a stand-still.

But laugh as you will, at that time Rube Goldberg machines will power your future. It probably will not be uncommon to see machines from the size of garbage cans to the size of two story apartment houses powering everything in sight. These machines will be using a force in nature never conceived by the conventionally trained mind of today.

The theory I am about to explain to you will bring you one step closer to gaining free energy.

To begin my story, I must state that I had a vision: looking for this energy. Many times I hammered my head into the ground, but I refused to give up in my search. Any person with a dream should never let it be wasted by fools, who will always say "you can't do that". All that statement really means is that they do not know how to do it.

There are many different ways to explain this theory. I will discuss the first one now.



The device is very simple and uses electronic circuits. Basically we drive a direct current motor with pulsed current from a battery, then utilize a special means to cause the battery to recharge itself.

First, the battery is connected to a simple flip-flop circuit which in turn drives a simple amplifier circuit. The load (motor) is connected to Q4 (2N5885, Figure 3), or between the positive pole of the battery and the collector of the output power transistor. As the motor starts moving forward, the load condition is decreased and the motor draws very little electrical energy. As the energy drawn from the battery is decreased, the flip-flop circuit goes faster and faster to a certain point, which determines the speed of the circuit; however, we can vary the speed by adding certain things that are also simple. The idea is to pulse the motor in a certain time frame, drive a flywheel of some mass, and convert the mass's angular momentum to energy for our use, giving back to the battery all we have robbed from it during one power pulse plus adding a little bit more.

An easy way to look at this is to say the battery is 12 volts. To charge this battery we need at least 2 volts over the battery voltage, so we need 14 volts applied in the correct direction. (See Figure 1.)

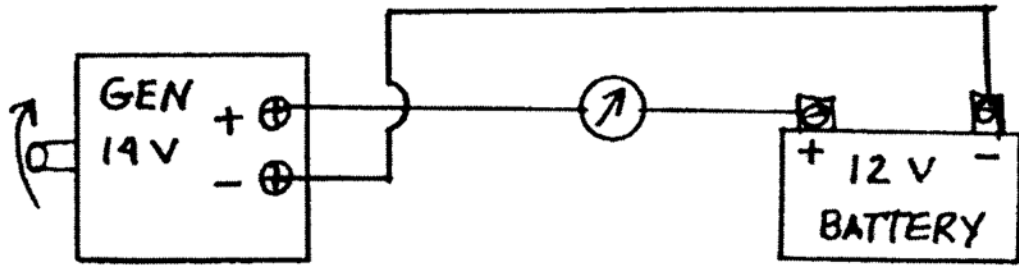

FIGURE 1. RECHARGING A BATTERY FROM A GENERATOR

Looking at Figure 1 we can see that the generator is at 14 volts and the battery is at 12 volts so we have a reverse flow condition in the battery, which means the battery is in a charging condition. If, however, the generator did not make 14 volts but say only made 10.5 volts, the generator would act like a motor and just drain the battery away and the current meter would show discharge.

So far, this is all just conventional theory on how batteries are charged, and this is all you will find in textbooks, except for some books that tell you how to make special power supplies to charge batteries faster. With the machine I am going to describe to you, we will do better than that; we can actually boil the battery away if the device is not properly constructed.

Let's begin by stating certain facts. The ions move backwards under charging conditions and in reverse under discharging conditions. So here we start our new concept. Suppose we have constructed a machine that has tricked this battery into a different space and time relationship. Simply put, suppose the battery never did

any work and it should have its full charge left in it. Suppose this becomes possible because we have stressed the terminals in such a way that the ions in the battery electrolyte actually move themselves backwards. The machine, or unit, that makes this possible has many different names. Some people call these units generators, energizers, alternators, etc. Conventionally such devices have one thing in common; they stress the battery backwards by pushing electricity to the battery and forcibly pushing the ions in the electrolyte backwards. In our theory we are not going to push anything - the ions are going to move themselves, recharging the battery.

If we go a little deeper into this theory, you are probably asking yourself "What is this madman talking about?" Simply put, we are going to put a stress on the battery terminals for a moment in time and the battery will do the rest.

Now comes the heavy part of this theory. What they didn't teach you in textbooks is that, in order for the battery to charge, two oscillatory actions must occur, one at the positive terminal and one at the negative terminal. Under different stress levels this then forces the ions backwards. The same would occur for an electron. Our machine will slingshot ions in the battery electrolyte backwards beyond the normal recoil action. (See Figure 2.)

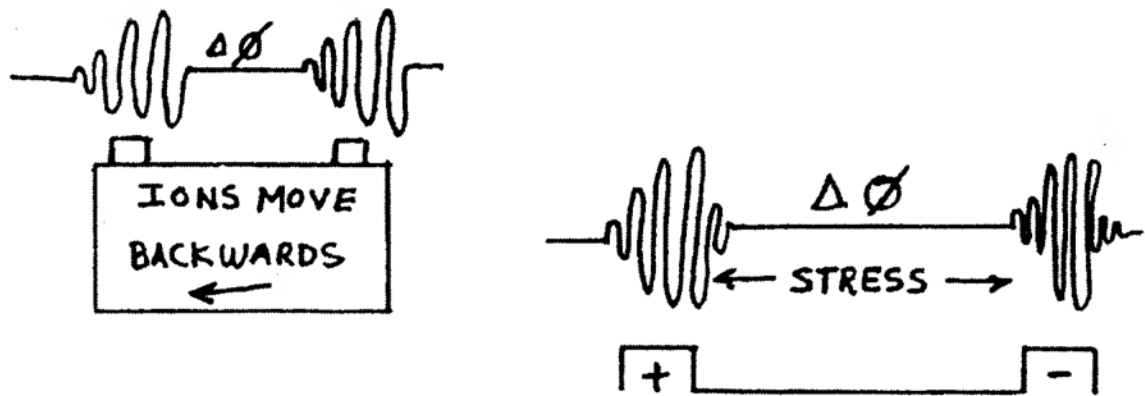

FIGURE 2. RINGING OF IONS IN THE BATTERY FROM A HAMMER EFFECT

I must give a very stern warning at this time that if the voltage developed is too high the battery will explode. Use the utmost care. Test setups in my lab have proven that this can be dangerous. Do not build the device and experiment with it unless you know what you are doing, and use the utmost caution.

When struck by a sharp voltage spike, the electrolyte in the battery will resonate at a certain frequency and this can also force the ions backwards. Simply put, the battery, the motor and the energizer will become resonant at some point, "ring" like a bell when we "strike" it, and in its ringing the most energy will be developed..

#### THE CONTROL CIRCUIT

For people who like to tinker and like electronics, these are the circuits I have used in my lab to examine this new concept.

## FREE ENERGY GENERATION

---

The circuit contains a very simple, free-running multivibrator circuit which is used to gate the operation of a two stage amplifier.

A motor or other load is connected in series with the collector of the output transistor, and each time the transistor conducts voltage, it will be applied across the load.

The input power may be any D.C. voltage from 6 to 24 volts.

The rectangular wave developed at the collector of the second transistor is resistively coupled to the base of the 2N5875, gating it on and off. This stage in turn gates the operation of the 2N5885 used in the output stage.

A motor is connected from the positive side of the battery to the collector of the output transistor. The motor pulses at the frequency of the multivibrator.

(See Figure 3 page 19.)

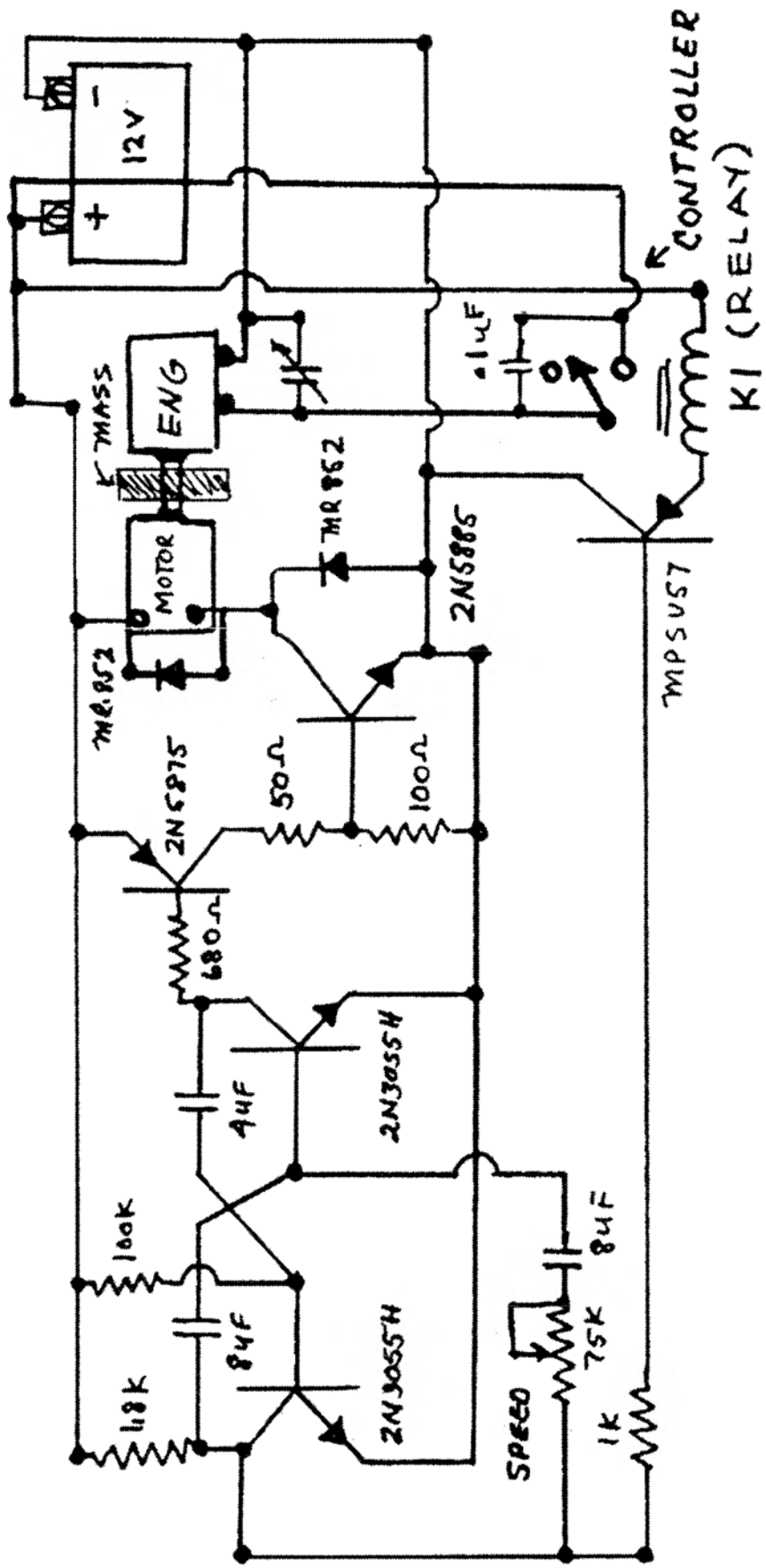

FIGURE 3. CIRCUIT FOR THE BEDINI FREE ENERGY DEVICE

In Figure 3 it must be remembered that the tuning of the circuit is very important in that the pulser circuit must be out of phase with the controller circuit. Those persons who have instruments to check this must connect the probes of an oscilloscope on channel A to the collector of the 2N5885 and ground the scope to channel B which must be across the battery. The wave forms should look like those shown in Figure 4.

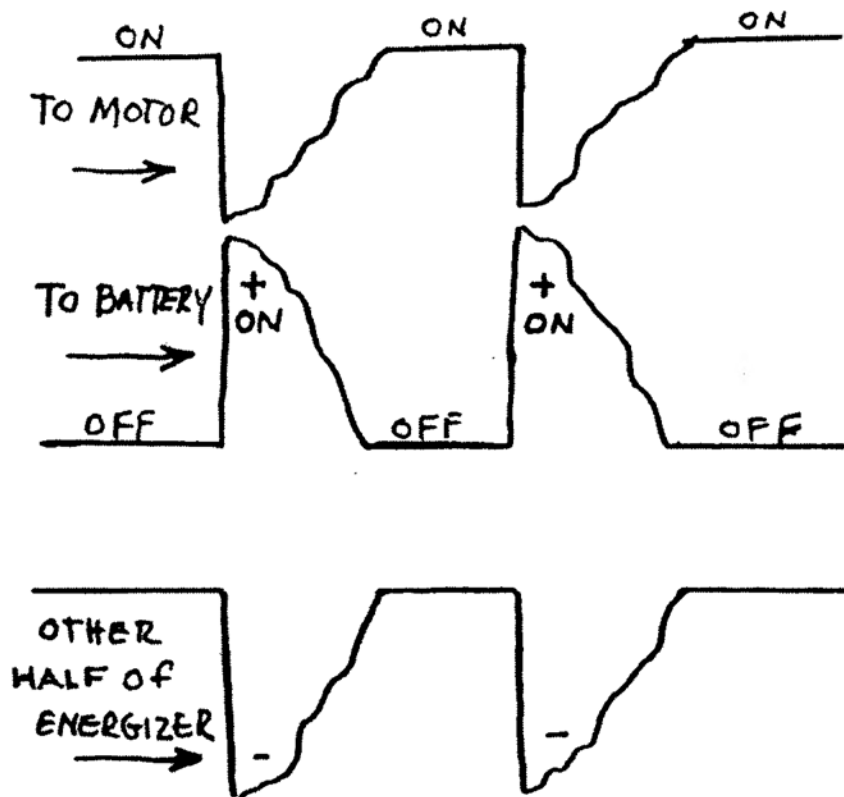

FIGURE 4. OSCILLOSCOPE WAVE FORM

In studying this new concept a little further, we see that something very unconventional is taking place here. The motor is very conventional as far as pulsed waveforms go, but the energizer is doing something very unusual. The waveforms from the energizer are telling us a new story. If we take the scope and expand these

waveforms out even further, around 50 MHz, the waveforms look completely different. (See Figure 5.)

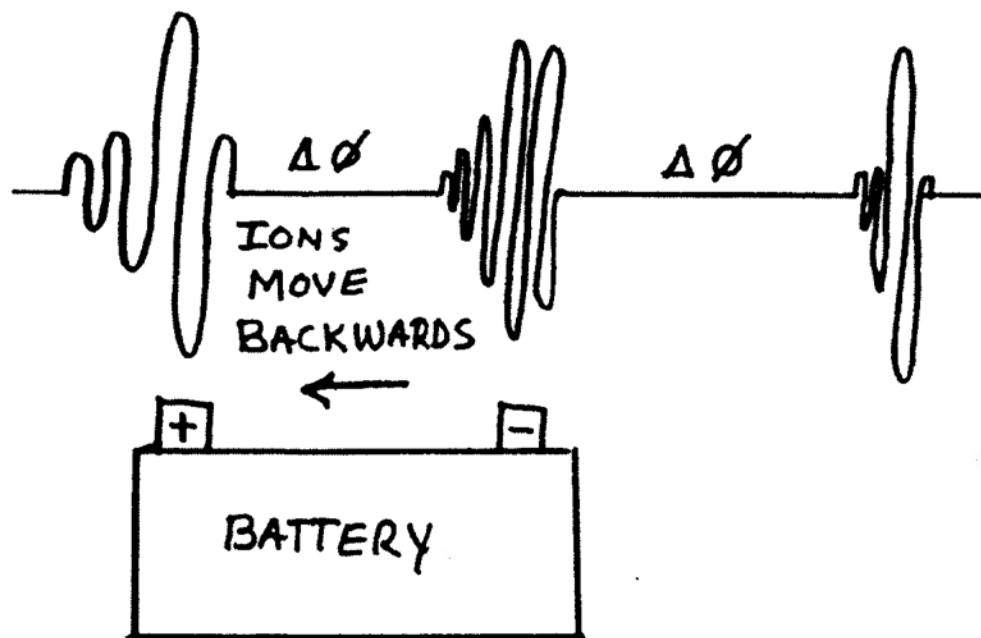

FIGURE 5. STIMULATED RESONANCE PROVIDES SELF-CHARGING

As we look at Figure 5 the story becomes clear. The battery is really charging itself. The ions in the electrolyte are being stressed in a curved space and time relationship; the battery is actually forced into believing that no work ever occurred. The oscillatory action that has taken place by the energizer has just pulsed our "slingshot" back and immediately let go. Once this has happened, the electrolyte in the battery goes wild and the ions race backwards, giving off hydrogen and oxygen gas.

I must make a stern warning here! The time of the stimulating pulse is very important. If the time is too long, the battery will burn itself out. If the pulse



time is too short or if the circuit fails to operate correctly, the battery will never recover its charge.

Taking this into consideration, the only failures that could occur would be the controller failing to operate due to a points failure, or the multivibrator latched in the "on" position. Anyone studying this can see that we have used very little energy to get to this point, and gained a lot of resonant energy in return.

We must remember that, if the battery is applied to the energizer longer than normal, we must burn up the excess energy to keep the battery cool. The problem becomes one of embarrassing excess of energy, not a shortage.

Now I have one question for you, what will you do with the excess energy and where did you get it?

#### THE ENERGIZER

The energizer is also a simple machine, but if you want to, you can make it very complex. The simple way is to study the alternator principles. The waves we want to generate are like those that come from old D.C. generators with the exception of armature drag, bearing drag and no excited fields. Also, we would want to cut the magnetic fields at 90 degrees to the armature. The simpler the better.

I am going to throw a few ideas your way. I have run some tests in my lab and discovered that certain types of energizers, generators and alternators do what we

need. Also, we want to be able to tune the output of our energizer. The old D.C. generator puts out something very close to what we need, except for the drag. (See Figure 6.)

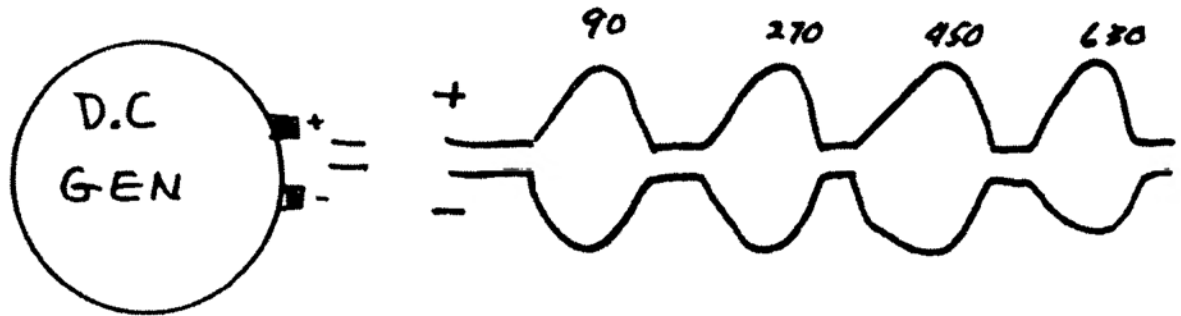

FIGURE 6. OUTPUT PULSES FROM A D.C. GENERATOR

Looking at Figure 6, this is pulsed D.C. and everybody will accept this, except me, because the other half has been left out once again. It is the same old story, wasting energy. Conventionally it is not important to know about the other half. Well, it is very important to me, because I need it to build my energizer.

The D.C. generator output actually looks like this when expanded. (See Figure 7.)

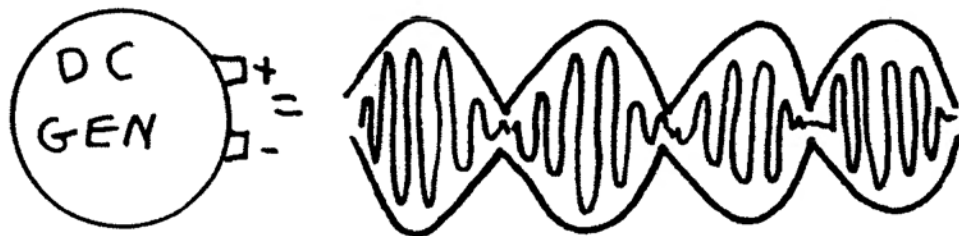

FIGURE 7. EXPANDED OUTPUT FROM A D.C. GENERATOR

In an A.C. generator output we are going to see just what we manufactured. (See Figure 8.)

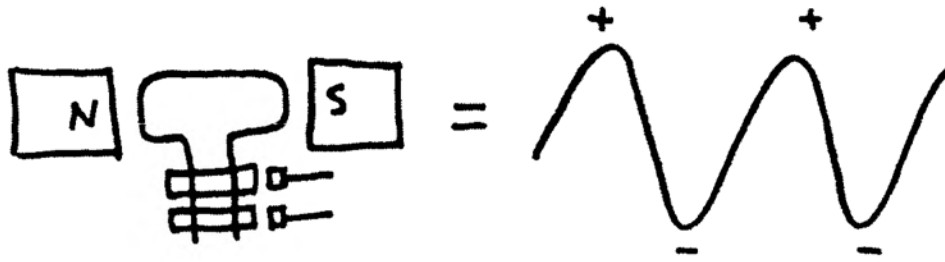

FIGURE 8. A.C. GENERATOR OUTPUT

It would appear that this leaves this generator out. Not really, because we can make this generator's output change by rectifying it. (See Figure 9.)

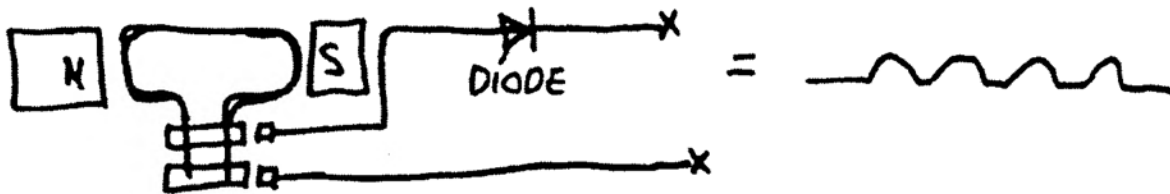

FIGURE 9. RECTIFIED OUTPUT FROM AN A.C. GENERATOR

In looking at the A.C. generator with rectified output, we see that it could become very useful to us as an energizer, simply because it is the easiest to construct and its principles are simple. I have done experiments with a little different variation of this machine, as shown in Figure 10.

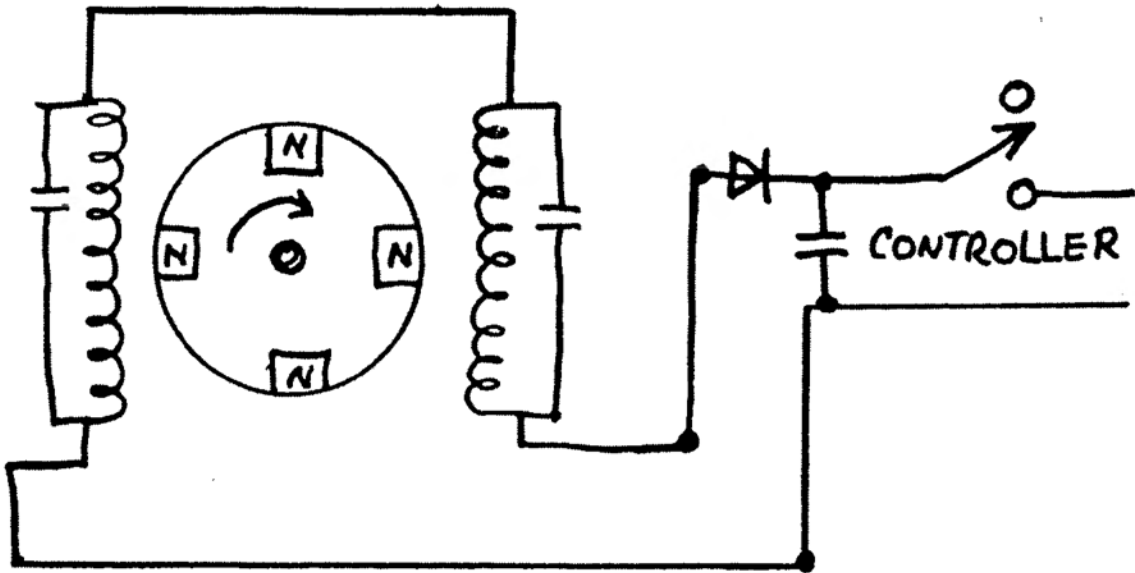

FIGURE 10. VARIATION OF A RECTIFIED A.C. GENERATOR

According to the conventional books, this alternator principle applies this way, as shown in Figure 11.

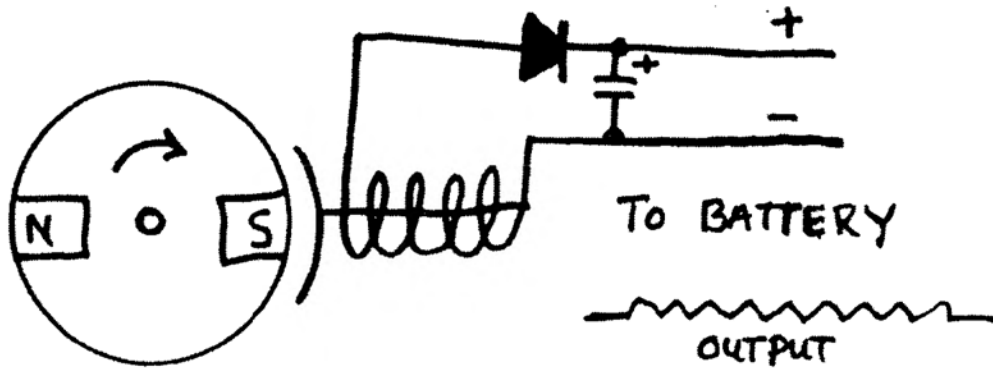

FIGURE 11. CONVENTIONAL EXPLANATION

In Figure 10 most people can see that the alternator drawn here might have some problems. However, remember that I am looking for a certain type of wave form that I want to tune to a certain frequency at a certain speed. The winding of this alternator is a problem and it is

tricky, but I chose to stay with this unit. You may choose a different method if you retain the principle.

### THE CONTROLLER

The controller is a simple piece of equipment to build; however the controller in Figure 3 could present certain problems if the contacts or points were to arc closed. If this were to happen, the motor soon would drain the energy from the battery and things would die.

There is another type of controller I must make known, and it is the simplest of all. With three brushes and a commutator, you can do away with all the electronics and handle 100 times the power back to the battery. The simplest method would be a split commutator, of which a little less than 180 degrees would be copper. (See Figure 12.)

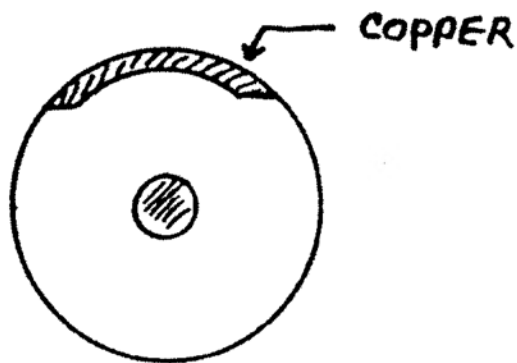

FIGURE 12. SPLIT COMMUTATOR

This split commutator is going to become our pulser and our controller, doing away with all the electronics. Just think - no transistors to fail, no relays to stick, no resistors to burn up and the best of all - no cost!

The only thing this unit requires is a little tinkering and later on you can add the vacuum advance.

But enough joking around! The next step is to build a good unit that will last a long time. You may choose to build any other version you wish. Now, we need three 12 brushes and you can begin to see how this is going to work for us. (See Figure 13.)

FIGURE 13. SPLIT COMMUTATOR WITH 3 BRUSHES

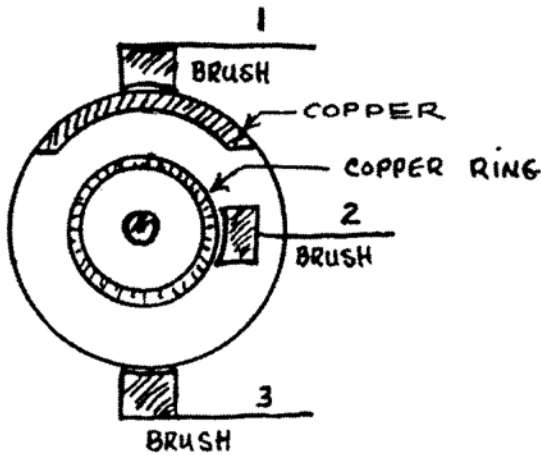

Figure 13A.

Physical Construction

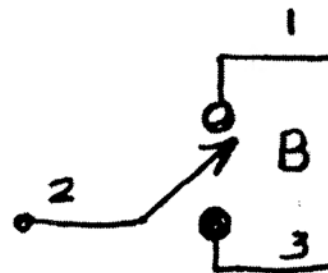

Figure 13B.

Equivalent Circuit

As we can see, the physical construction (Figure 13A) is nothing more than a simple switch (illustrated in Figure 13B). The thing to remember is that this commutator is completely insulated from the shaft; otherwise the bearings will arc in the motor and the heavy mass, or flywheel, will chew the bearings up. This controller only has one function - to gate the energy from the

battery and to return it in the opposite direction. You have already seen the wave forms earlier in this paper.

There may be some tinkering around to be done with brush 1 or brush 3, depending on which way you want to hook it up. Also, once again, the timing between brush 1 and brush 3 is very important.

Let's look at the way this would be hooked up. (See Figure 14 on page 28).

If you hook up the components as shown and tinker with it until you get a stimulated resonance-coupled system, you will have a free running motor that powers itself and performs useful external work as well.

I think I have presented the facts as they really are. The machine is simple and not complicated. If built and adjusted correctly, this unit should supply energy for whatever you need.

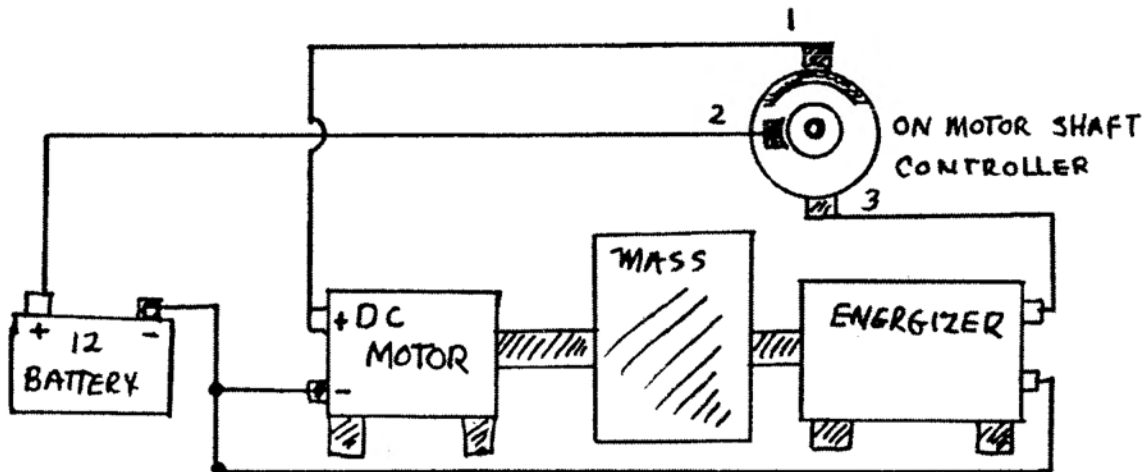

FIGURE 14. PROTOTYPE HOOKUP

A photo of a prototype is shown in Figure 15 on 31 and on page 32 is a diagram of the device I am now building as the second phase of this development.

The devices shown are my original concepts, of which I have actually built several working models. These have been witnessed by reliable observers. Several of these units are being constructed by friends and acquaintances, based on my instructions.

For those who wish to build and make improvements in the units described, the very best of luck to you. I am willing to offer suggestions to those who are truly involved and need some assistance.



John C. Bedini April 9, 1984



CONSTRUCTION NOTES

For those interested in building and experimenting with a free energy unit, a brief description of the basic components used in the original prototype is as follows:

MOTOR - G.E. permanent magnet, 1100 RPM, 1/12 h.p. This motor draws approx. 10 amps on pulses on start-up. As the speed of the motor increases, the amperage will decrease to about 1 amp on pulses. Permanent magnet motors are suggested based on good efficiency.

BATTERY - 12 volt, 12 amp-hour motorcycle battery.

ENERGIZER - A standard office type 2-speed A.C. fan was used for the housing. The coils were replaced with 6 coils of approx. 200 turns of #20 wire - all in phase. Six permanent magnets are bonded to an aluminum disc. The arrangement should be similar to that shown in Figure 16a/16b. This arrangement is basically a magneto, but will produce more amperage than ordinarily expected of a magneto.

CONTROLLER - If the controller as shown in Figure 13 is used, it is important that provision be made to rotate the brushes in relationship to each other in order to secure the required timing.

The author again wishes to stress the fact that while the circuit and apparatus is not complicated, a great deal of "tinkering" may be required to obtain efficient operation. Much is yet to be discovered in the con-

struction and operation of such a unit, but the first major step has been made.

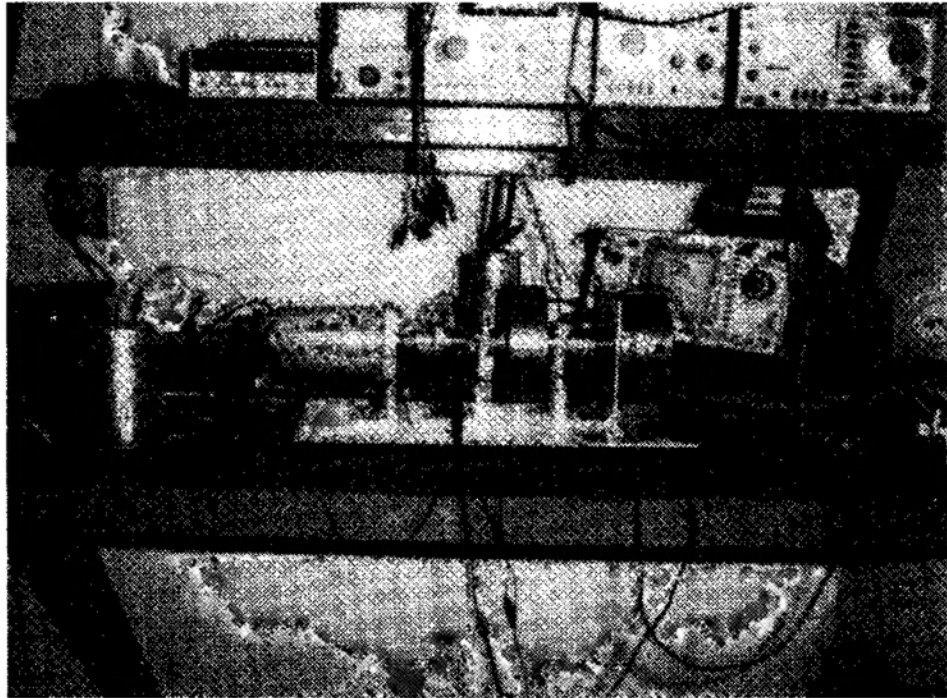

Figure 15. Prototype of Free Energy Unit

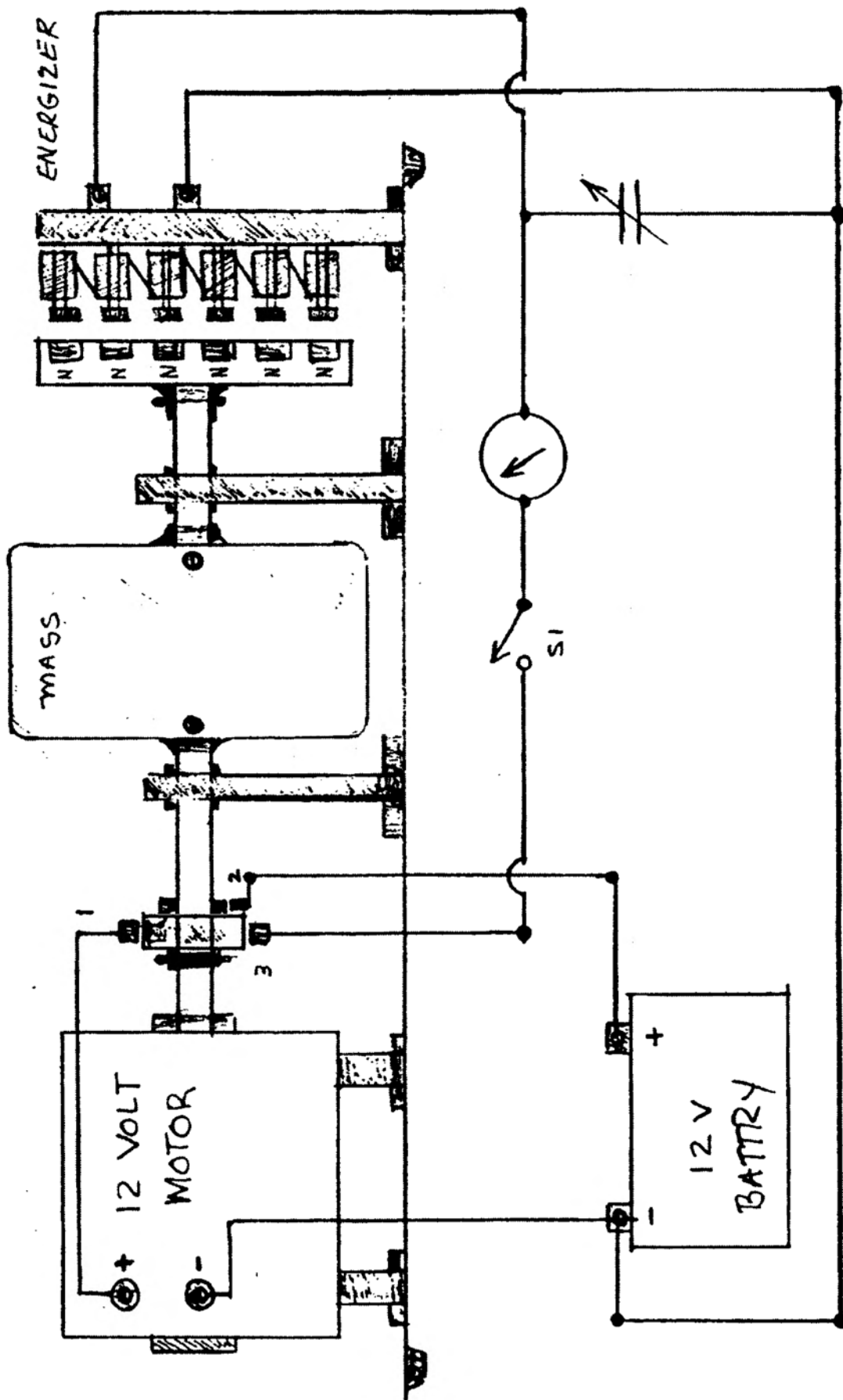
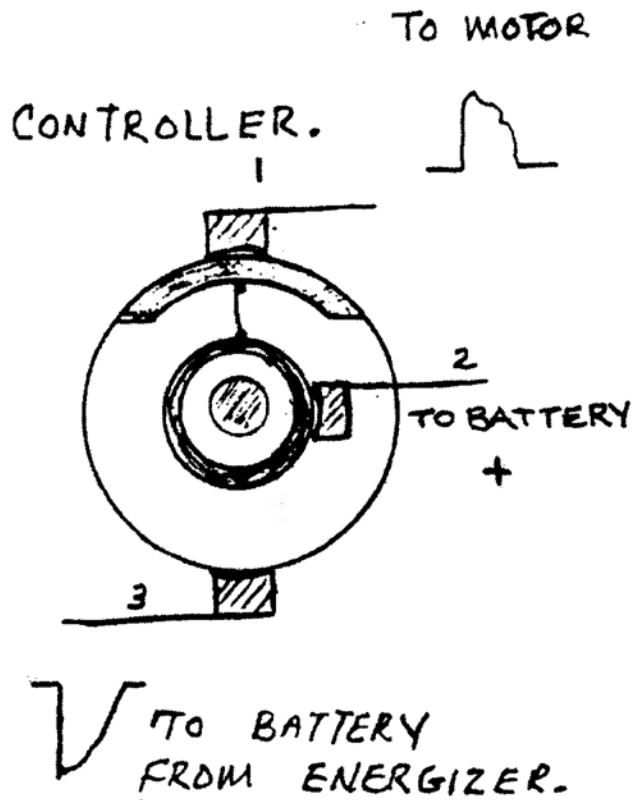

Figure 16a. Bedini's Test Model No. 2



Patent Pending

Figure 16b. Bedini's Test Model No. 2 (Controller)



NOW

**RADIANT POTENTIAL ENERGY CHARGER**

Provisional Patent Application of  
John C. Bedini and Thomas E. Bearden

August 15, 2003

Updated February 25, 2004



## Document Setup and Figures

In this section, we give the setup of the provisional patent application document, and also show the figures illustrating the background of the invention and the invention itself, plus various selected embodiments.

We first present the figures on separate pages, in this Section 0, so that all figures are clearly reproduced in the beginning. This includes the figures necessary to explain the background information. It is necessary to understand the background information before the operation of the invention can be understood, since the invention can only be described in terms of a mix of quantum field theory, particle physics, higher group symmetry electrodynamics, etc. It is not describable simply by electrical engineering.

Following those figures are the figures of the invention itself, both in terms of circuit diagrams and various embodiments showing typical applications of the invention.

- Energy exchange between active environment and system
- Exchange need not be in equilibrium
- Proven in modern particle physics
- Arbitrarily absent in electrical power system engineering

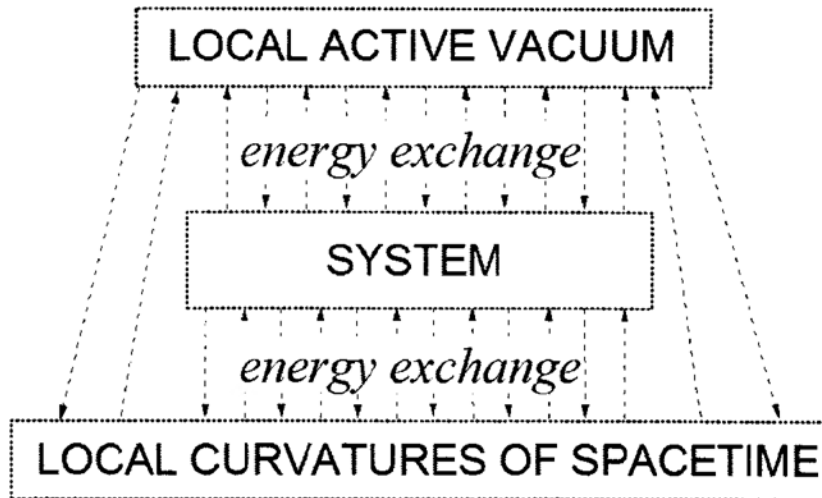

FIGURE 17. THE SUPERSYSTEM



- System is an "inert" system
- No environmental energy input
- All energy input is paid for by the operator

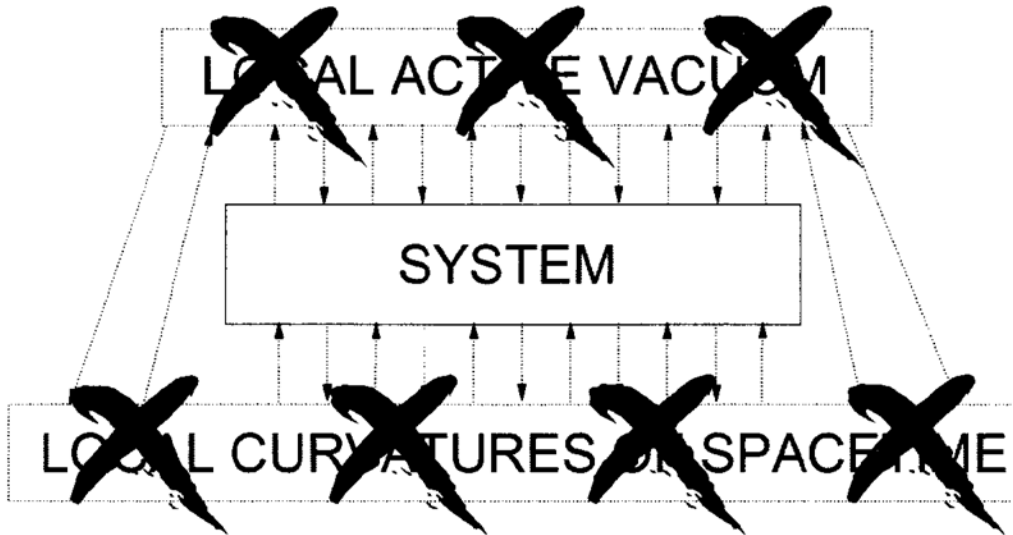

FIGURE 18. ELECTRICAL ENGINEERING EXCLUDES THE SUPERSYSTEM AND ITS COMPONENT INTERACTIONS

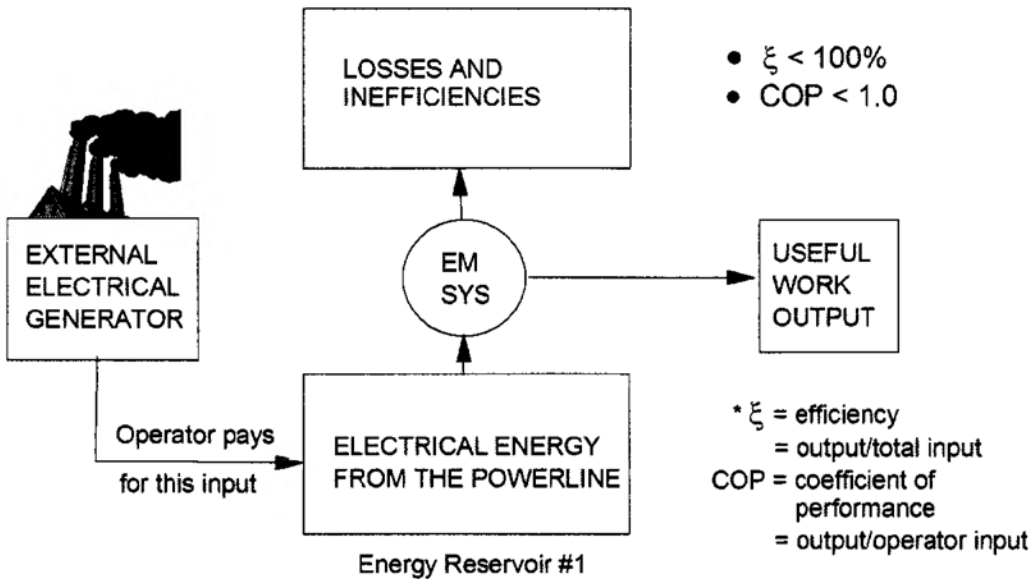

FIGURE 19. OPERATION OF THE NORMAL ELECTRICAL POWER SYSTEM

$\xi$  may be only 17%, and 83% of all the input energy is "wasted" by the solar cell array. But the remaining 17% is free, and so the

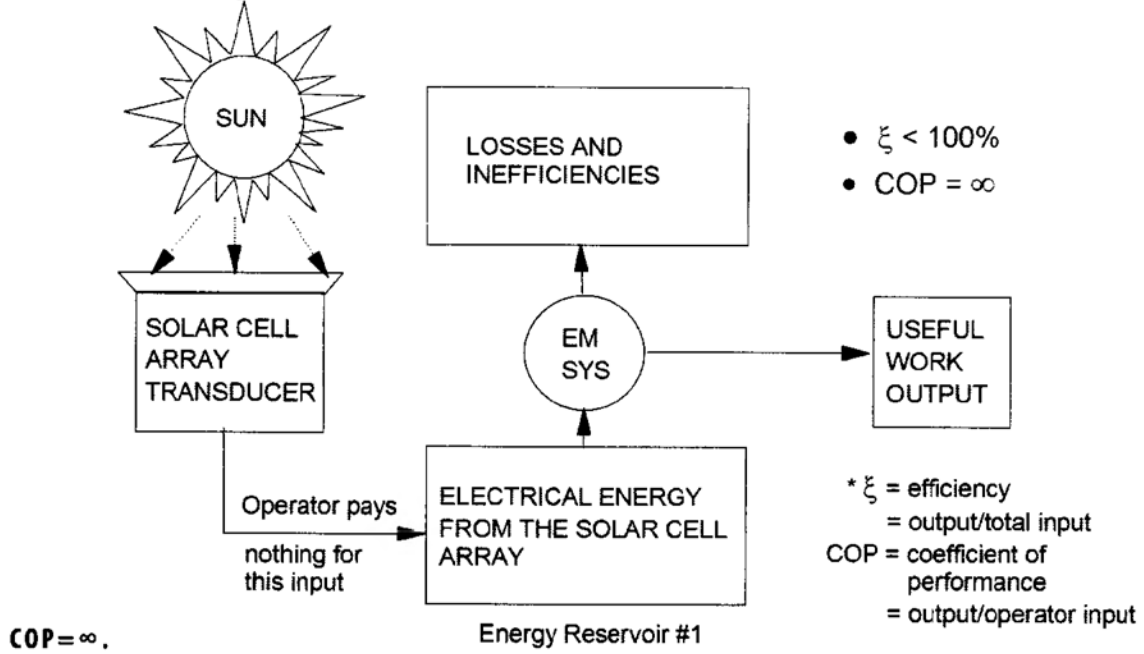

FIGURE 20. OPERATION OF THE SOLAR POWERED ELECTRICAL POWER SYSTEM

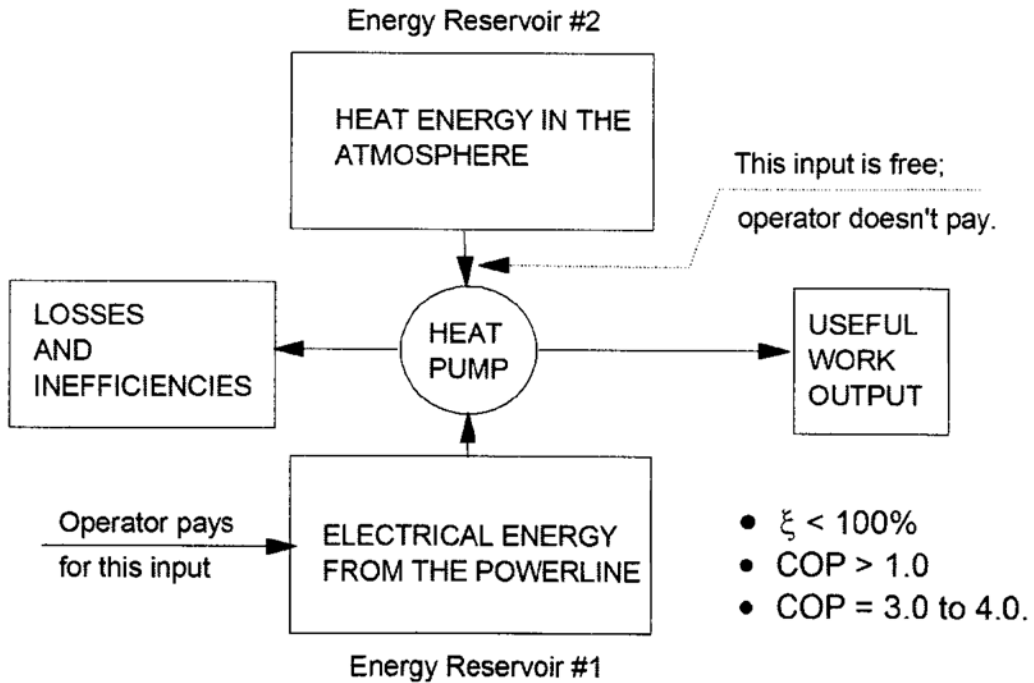

FIGURE 21. TWO-RESERVOIR REPRESENTATION OF THE COMMON HEAT PUMP

FREE ENERGY GENERATION

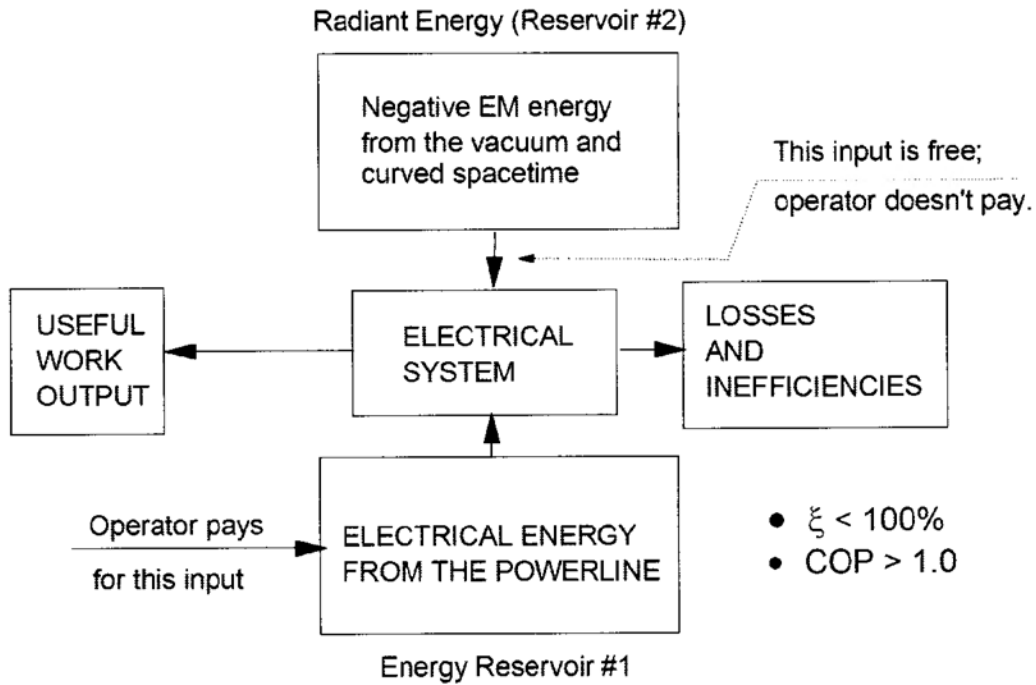

FIGURE 22. OPERATION OF THE INVENTION IN  $1.0 < COP < \infty$  MODE

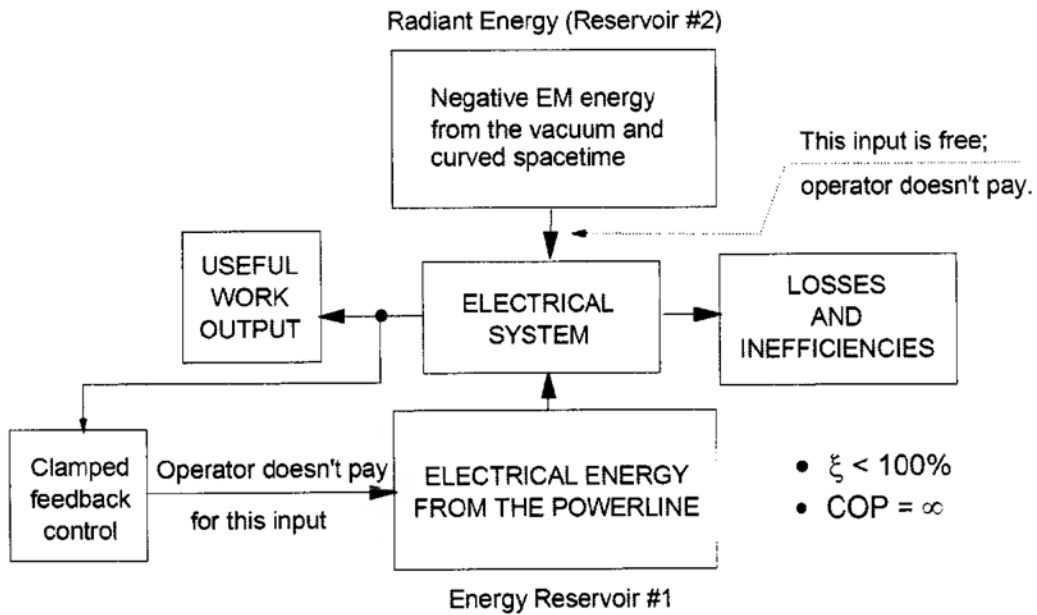
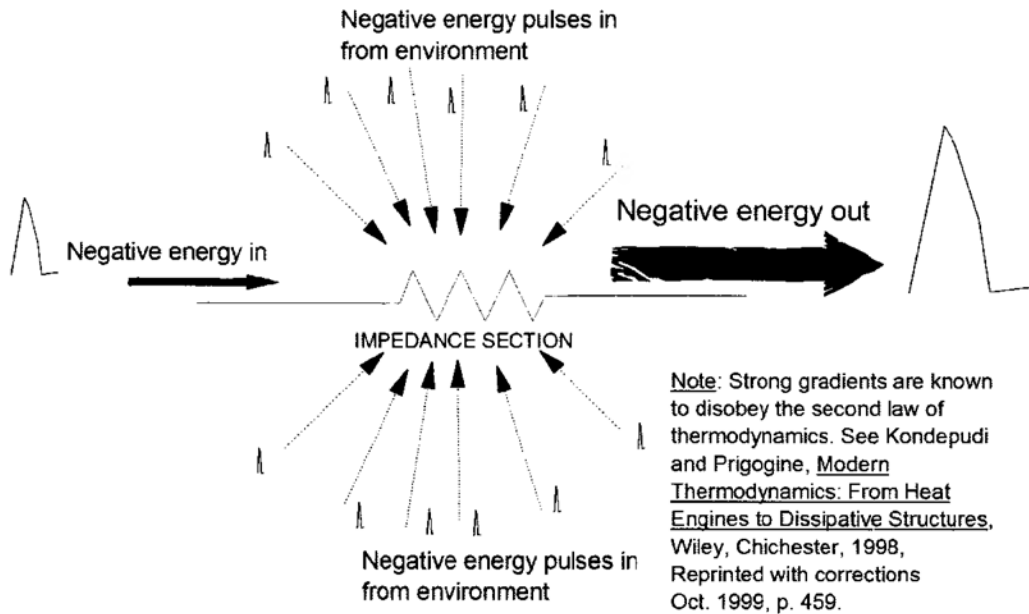

FIGURE 23. OPERATION OF THE INVENTION IN  $COP = \infty$  MODE

# FREE ENERGY GENERATION

---



*Negative EM energy converges rather than diverges.  
Amplification effect in resistance, inductance, and capacitive sections.*

**FIGURE 24. MECHANISM FOR AMPLIFICATION OF NEGATIVE ENERGY FLOW IN IMPEDANCE SECTIONS, FOR SHARP GRADIENTS**

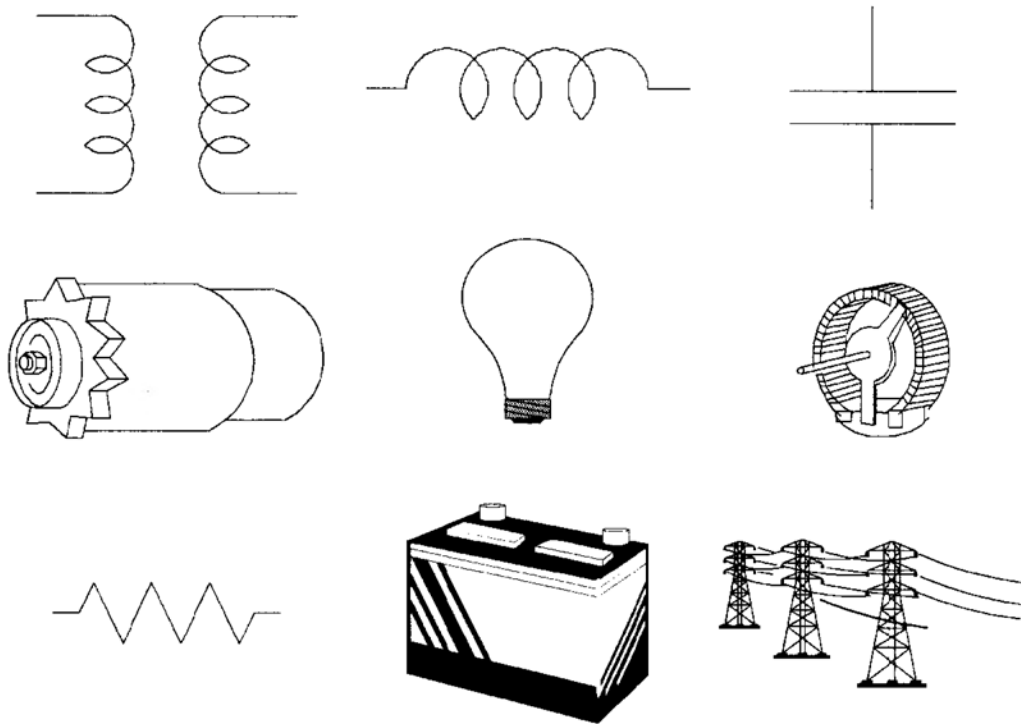

**FIGURE 25. TYPICAL CIRCUIT ELEMENTS THAT HAVE IMPEDANCE AND EXHIBIT AMPLIFICATION OF NEGATIVE ENERGY FLOW, FOR SHARP GRADIENTS**

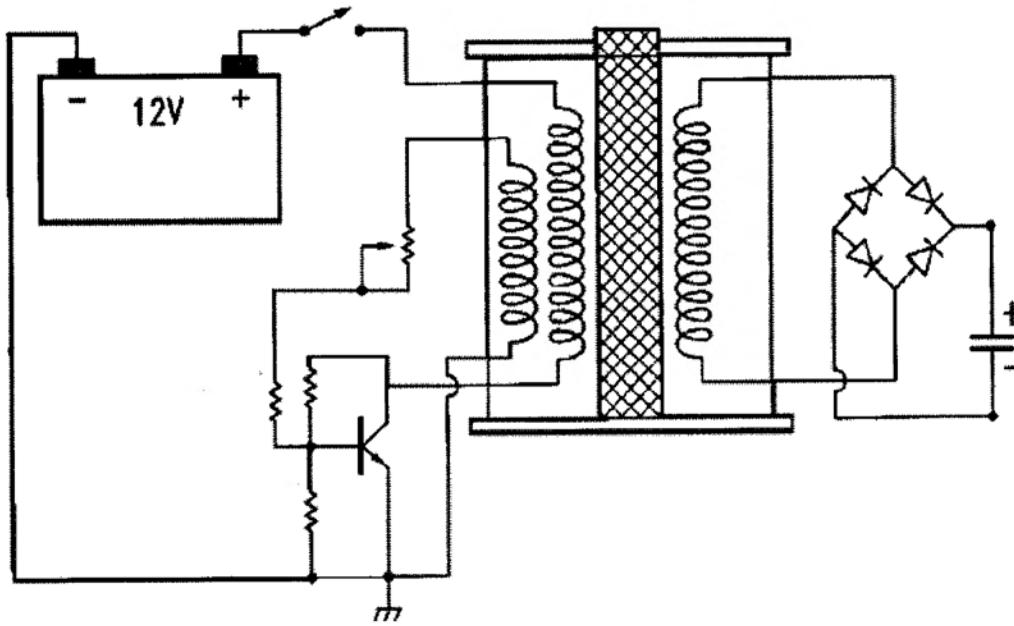

FIGURE 26. INDUCTANCE-COUPLED IMPEDANCE-MATCHING TRIGGER DEVICE

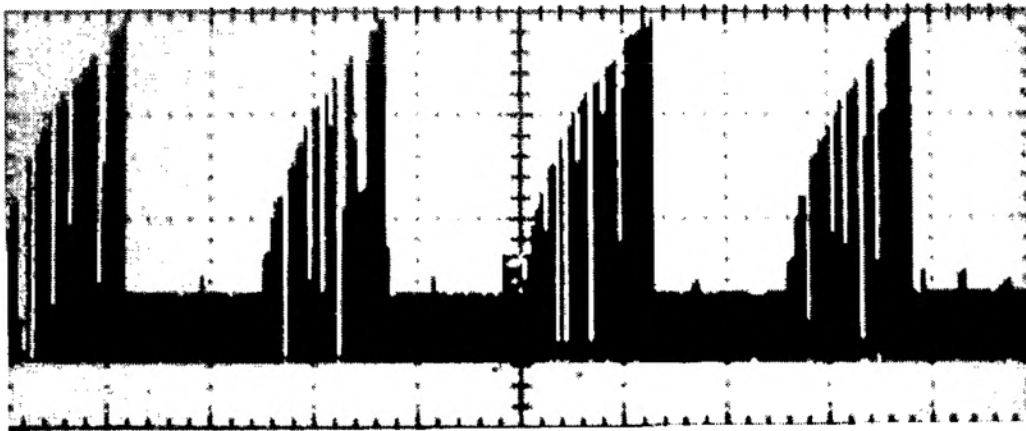

FIGURE 27. PULSE OUTPUTS FROM THE OSCILLATOR-TRIGGER UNIT

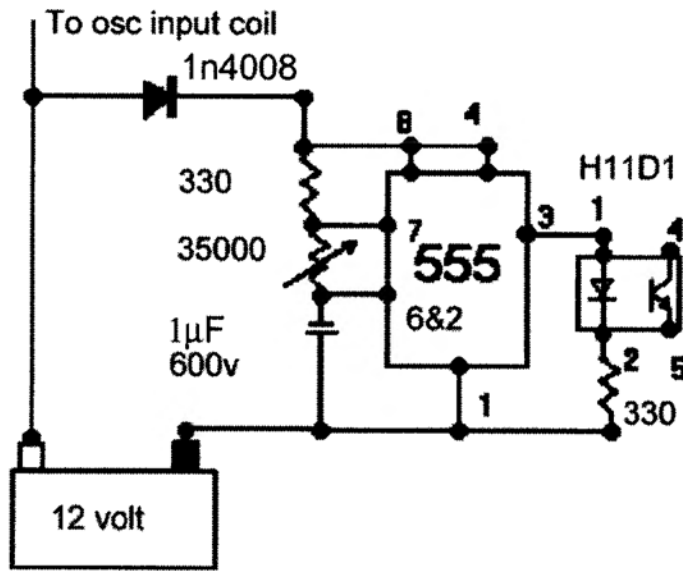

FIGURE 28 FREE RUNNING 555 TIMING CIRCUIT

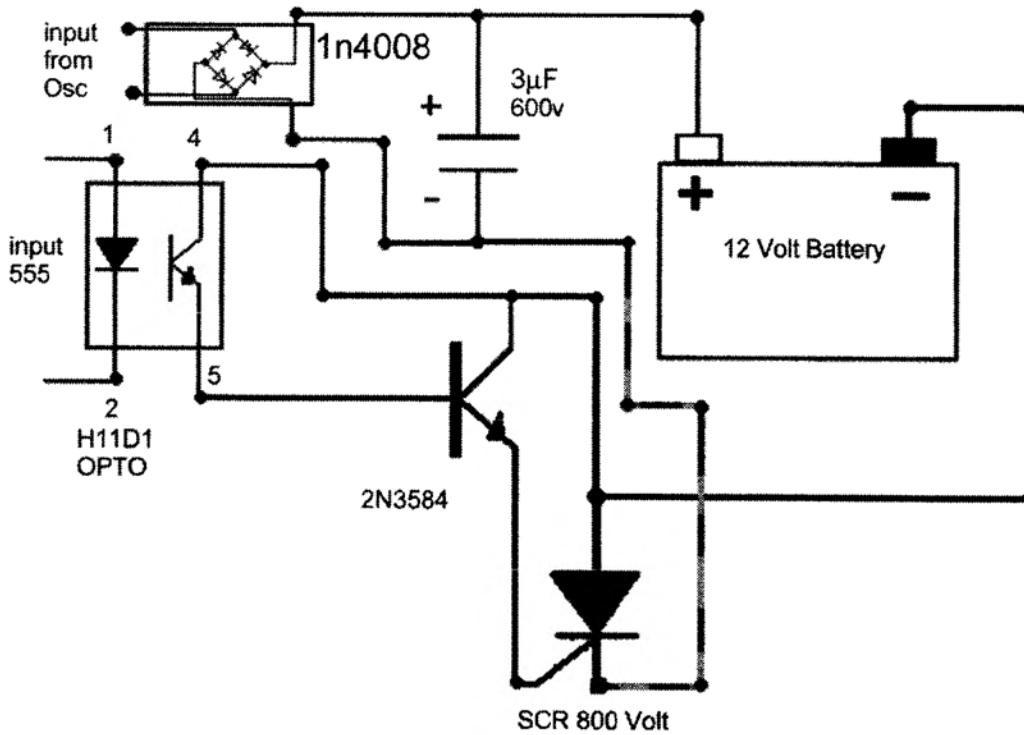

FIGURE 29. HIGH VOLTAGE SWITCHING, E-AMPLIFICATION, AND BATTERY CHARGING OPERATION

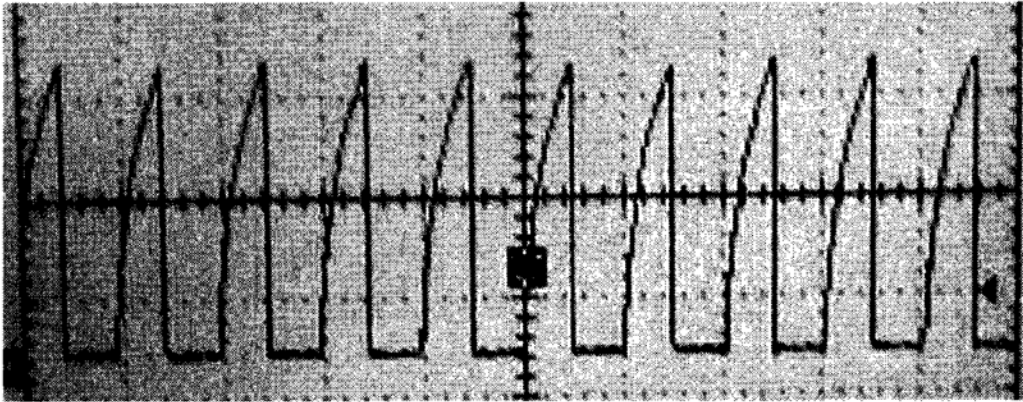

FIGURE 30. HIGH VOLTAGE SWITCHING ACROSS THE BATTERY IN FLOATING GROUND SITUATION

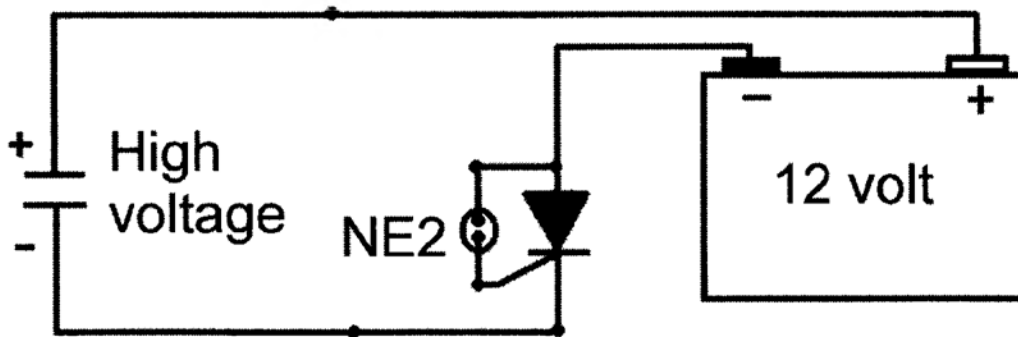

FIGURE 31. SCHEME FOR BATTERY CHARGING FROM AN ENVIRONMENTAL HIGH VOLTAGE SOURCE

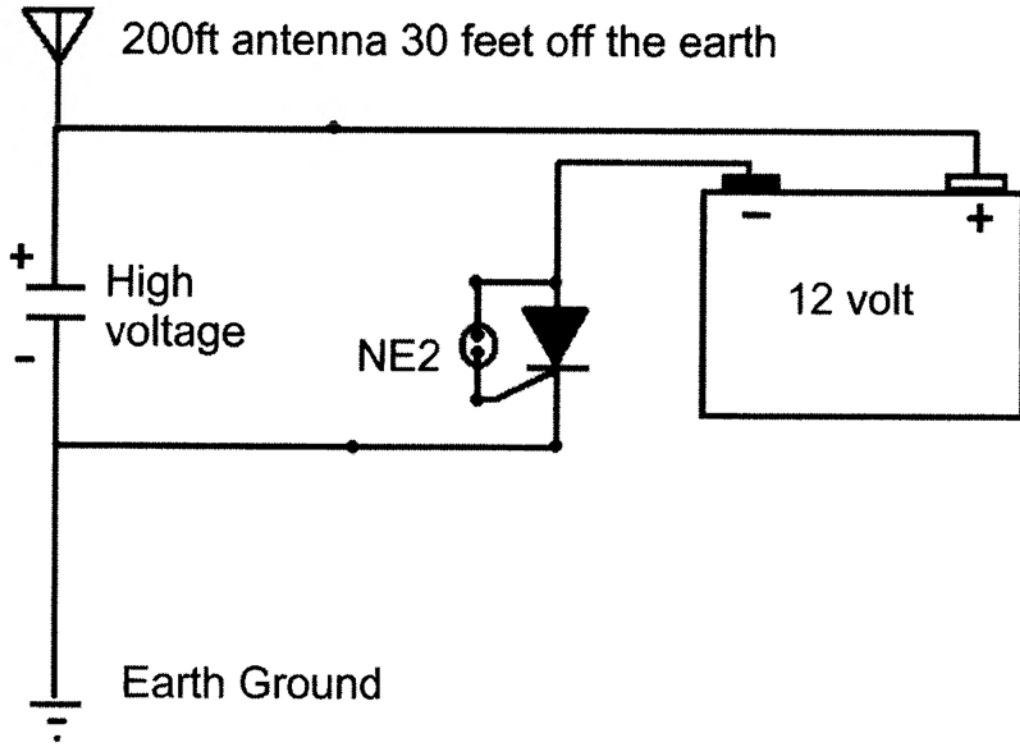

FIGURE 32. EXTERNAL ELEVATED ANTENNA FOR NEGATIVE ENERGY CHARGING OF BATTERIES



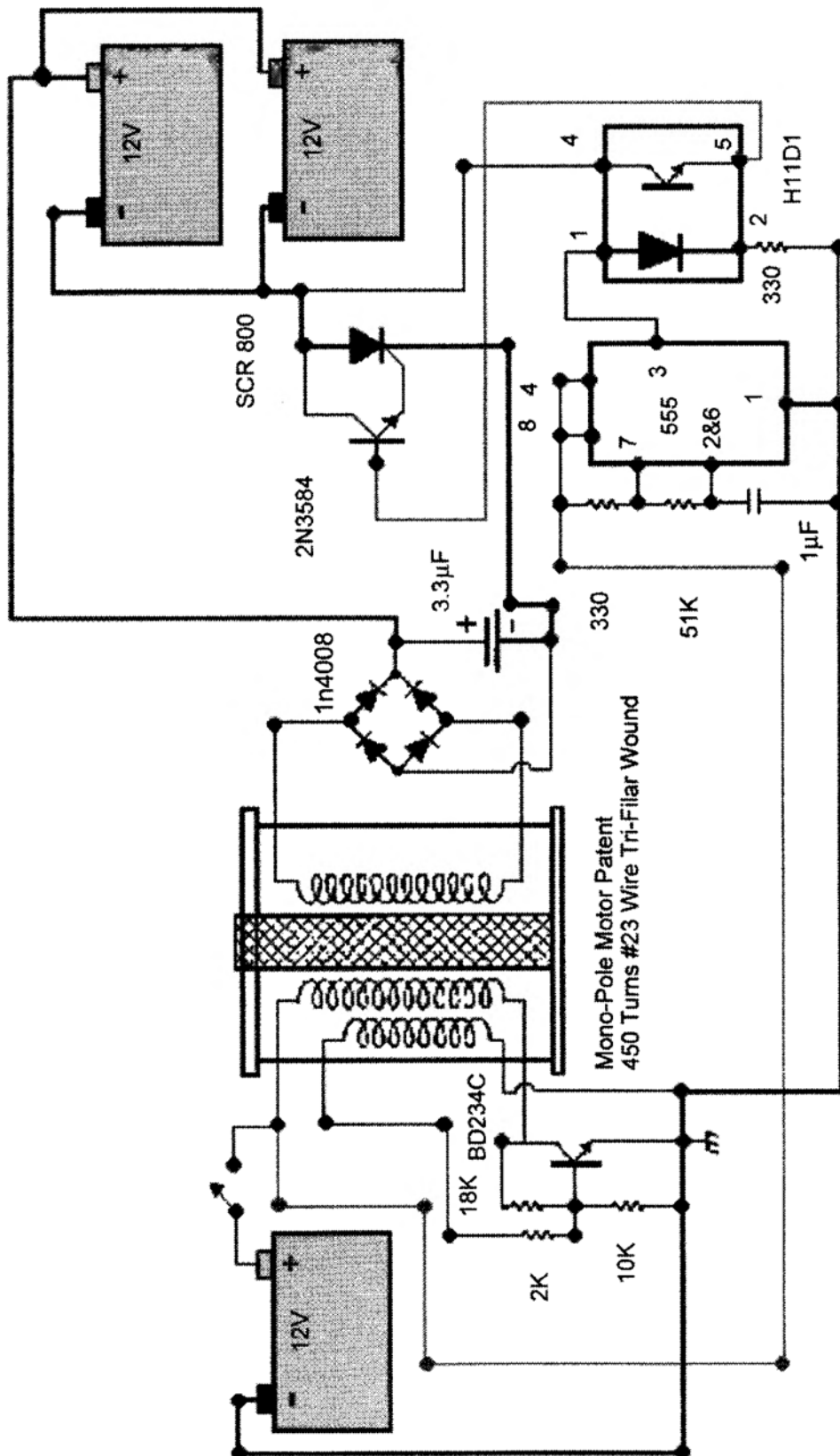

FIGURE 33. FULL DIAGRAM OF THE RADIANT ENERGY CHARGER USING AN SCR

# FREE ENERGY GENERATION

Erratum for Free Energy Generation by John Bedini and T.E. Bearden, 1st printing  
 Copyright (C) 2007 Cheniere Press. All Rights Reserved.  
 This replacement page 46 may NOT be reproduced or distributed without the express written consent of Cheniere Press. DO NOT COPY.

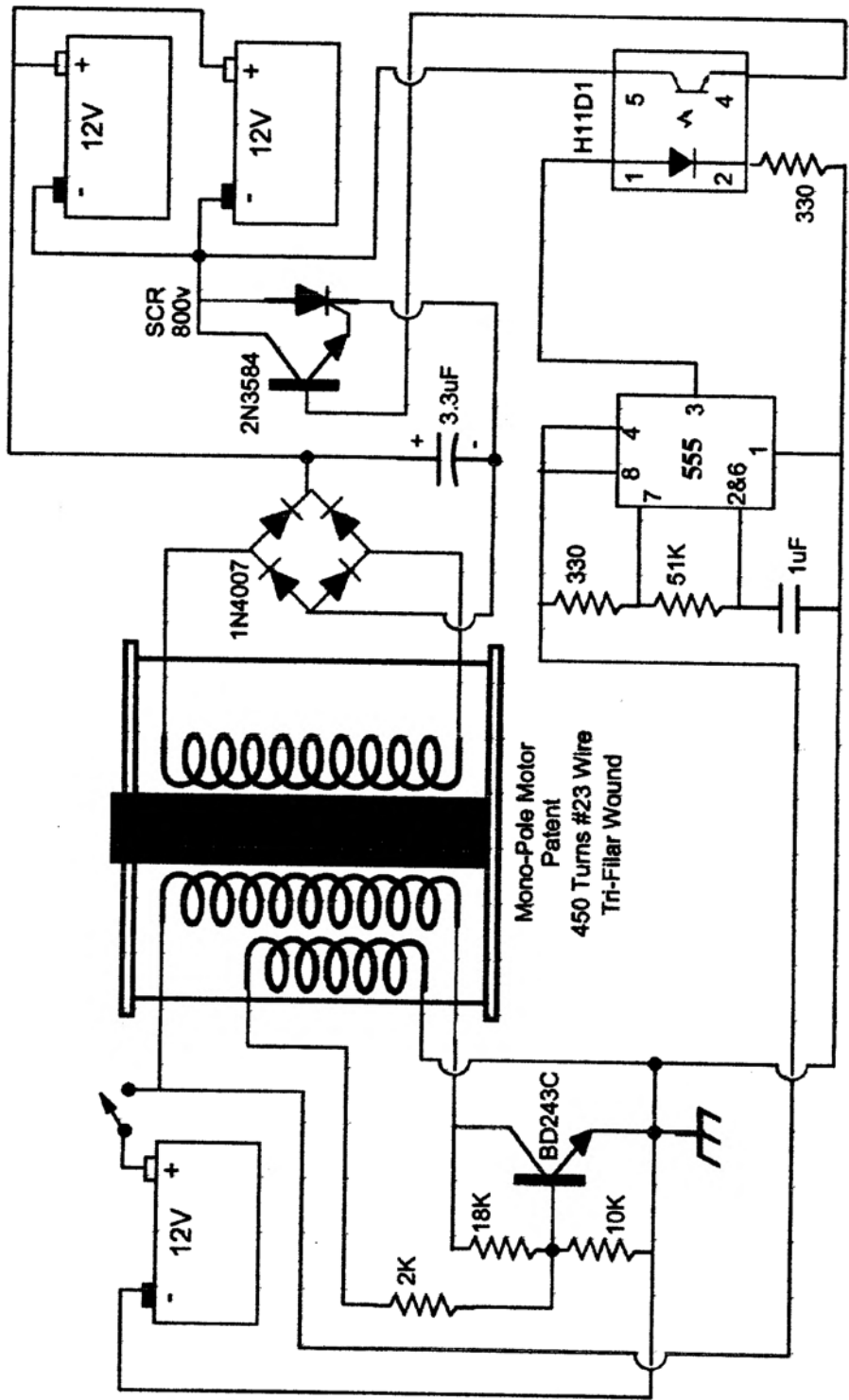

FIGURE 33. FULL DIAGRAM OF THE RADIANT ENERGY CHARGER USING AN SCR

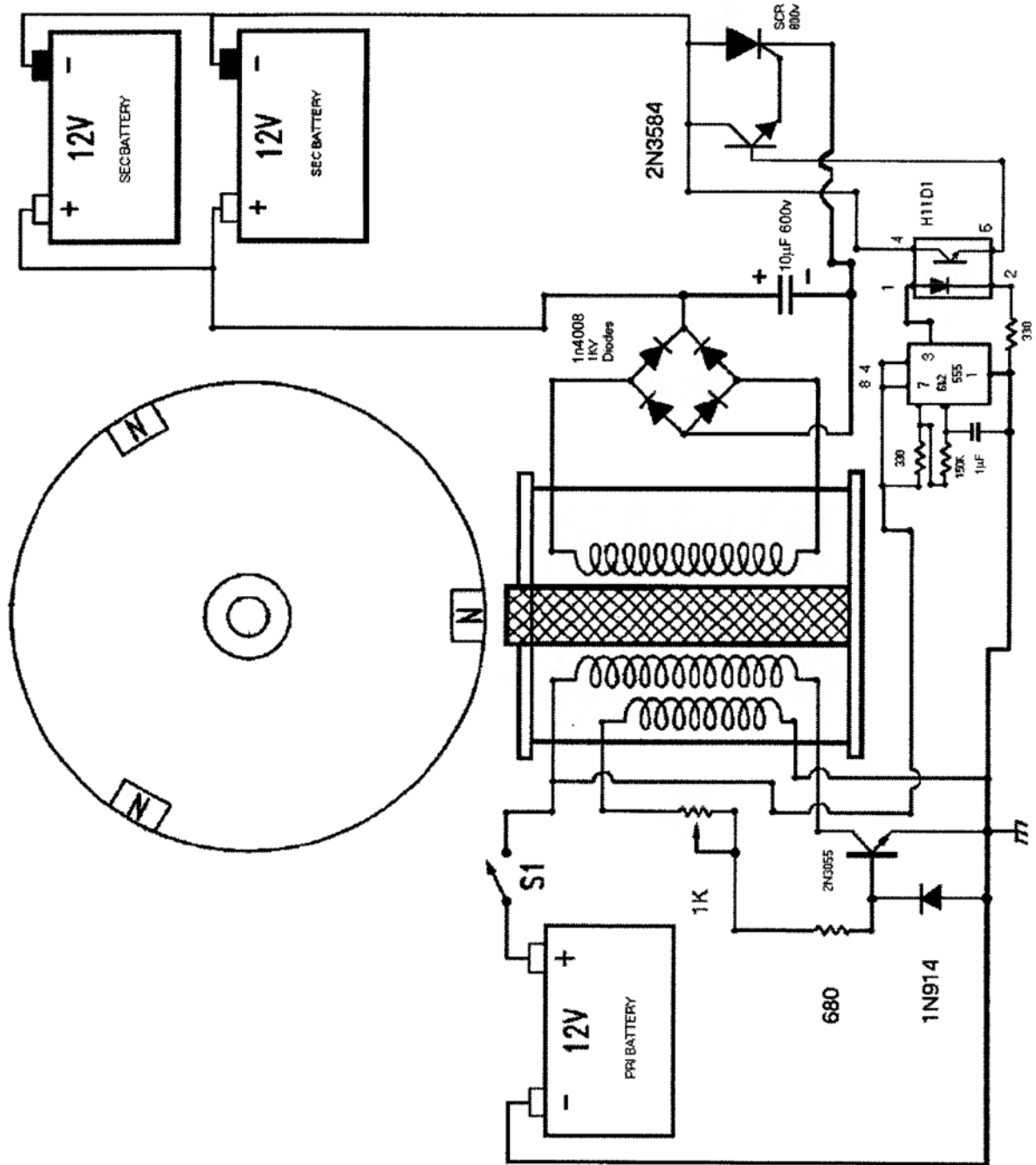

FIGURE 34. RADIANT ENERGY POWERING OF THE MONOPOLE MOTOR

# FREE ENERGY GENERATION

Erratum for Free Energy Generation by John Bedini and T.E. Bearden, 1st printing  
 Copyright (C) 2007 Cheniere Press. All Rights Reserved.  
 This replacement page 47 may NOT be reproduced or distributed without the express written consent of Cheniere Press. DO NOT COPY.

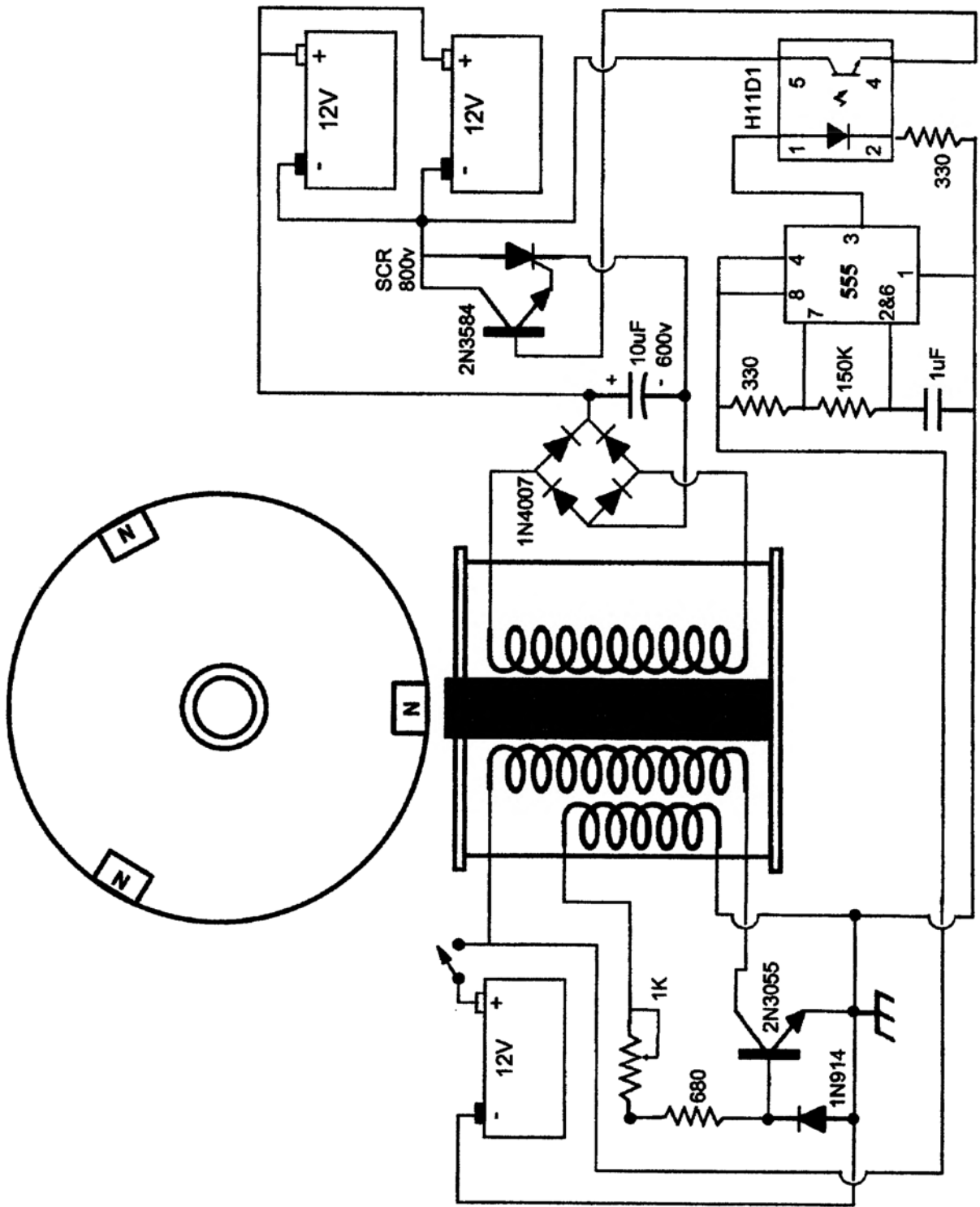

FIGURE 34. RADIANT ENERGY POWERING OF THE MONOPOLE MOTOR

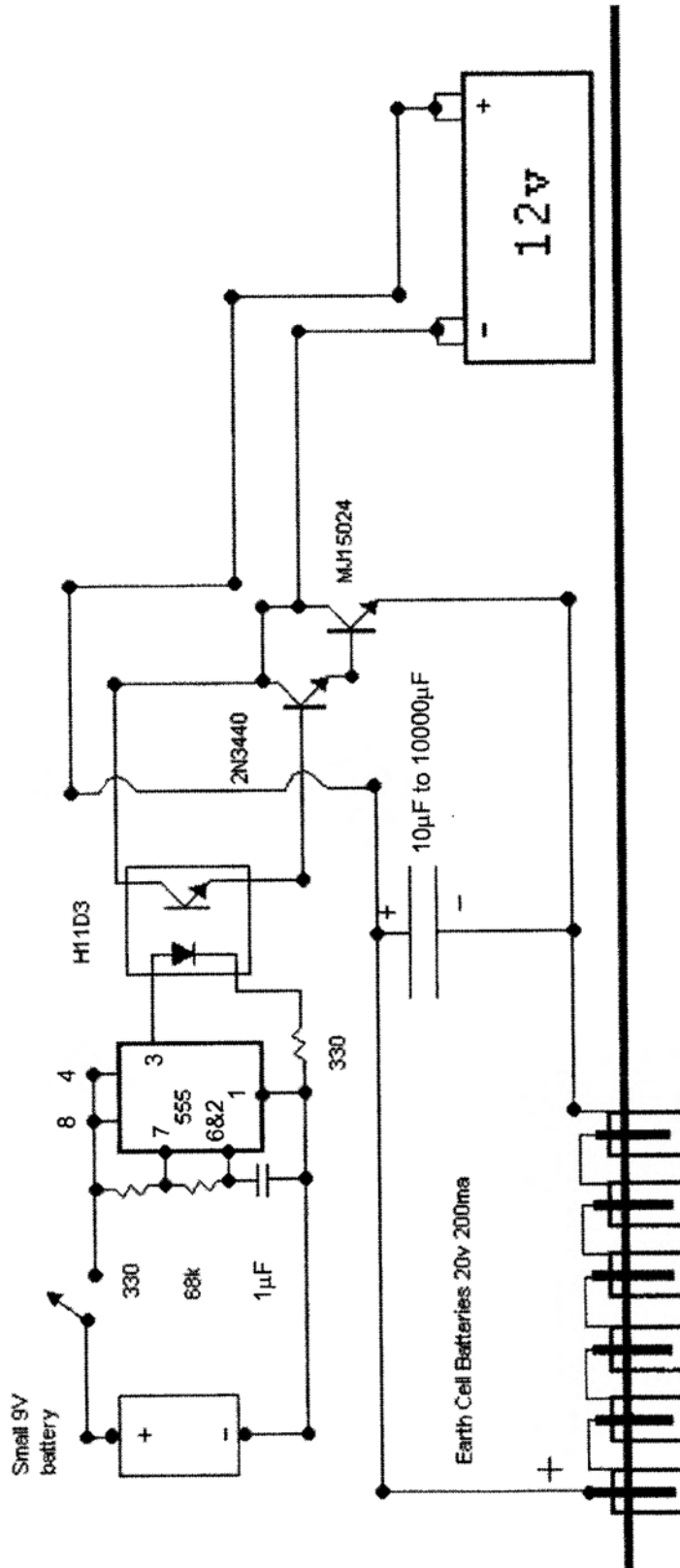

FIGURE 35. USING EARTH CELLS WITH THE POTENTIAL SWITCH AND A TRANSISTOR

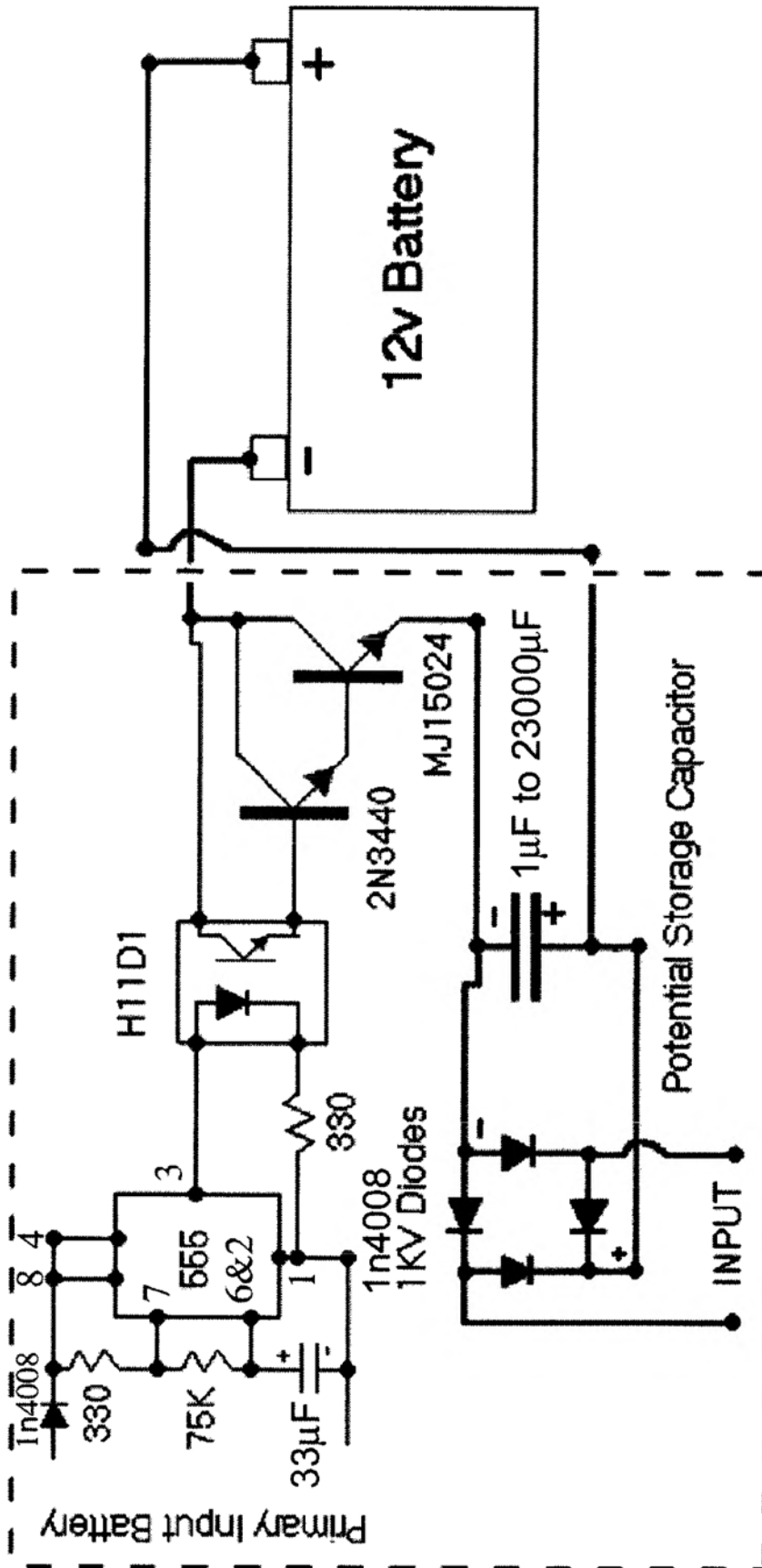

FIGURE 36. THE INVENTION SHOWN AS AN INVERTED POTENTIAL SWITCH



## Section 1: Background Information

### 1.0 Introduction

Because of the novel nature of the invention and its use of a unified field theory of electrodynamics, the active vacuum and local curvatures of spacetime participate and interact with the system in a manner which cannot be assumed to be a net zero. Indeed, the major object of the invention is precisely to (i) engineer and alter the active vacuum environment, (ii) engineer and alter the local curvatures of spacetime, and (iii) take advantage of the ensuing energy exchange between these active environments and the system, in order to provide a system far from equilibrium in said active environments, with the system freely receiving and utilizing excess energy from them, both in conventional positive energy form and unconventional negative energy form.

The operation of the invention is not describable in terms of just conventional electrical engineering and classical electrodynamics alone. Instead, the physics of the active vacuum and its interactions with charged matter are involved, as well as the physics of curved spacetime and its interactions with charged matter.

The invention also exploits a unique discovery: Using sharp gradients and sharp pulses, the invention stimulates receipt of *negative electromagnetic (EM) energy* from the vacuum. Further, the only limit on how much negative EM energy can be stimulated and received in the system is the sharpness and peak intensity of the gradient, plus the frequency of producing the gradient, plus the ability of the circuitry to catch and store the negative energy in capacitors, thereby also converting the energy into positive energy. In stimulating the negative energy inflow into the system from the sharply perturbed vacuum, a novel way of utilizing the Dirac Sea is stimulated and employed.

Some special characteristics of negative energy are given, as well as some of the special interactions in normal circuitry. We have nominated negative energy as also what astrophysicists call “dark energy” and sometimes “quintessence” and explained why {1}. Every university teaches the Poynting energy flow theory, which only considers a minute fraction of the energy flow generated through space outside the circuit conductors—specifically, the fraction that actually gets diverged into the conductors to potentialize the Drude electron gas. When the huge *additional* Heaviside component of energy flow in curl form—present but *nondiverged*, and arbitrarily discarded by Lorentz—is accounted, then the EM negative (“dark”) energy produced in sharp astrophysical gradients is sufficient to cause the widespread antigravity that is accelerating the expansion of the universe. It is odd that astrophysicists are looking as deeply into the early universe in the sky as can be seen, intensely searching for dark energy—when it can readily be found right on the bench and used in any circuit with slight modifications, by utilizing the novel teachings of the present invention.



Accordingly, this Section briefly summarizes the necessary additional background required from particle physics, quantum field theory, Dirac Sea theory, quantum mechanics, and higher group symmetry electrodynamics, and includes appropriate literature citations. Since the invention uses field energy in mass-free space, wherein said field in the absence of mass is not a force field, we shall refer to energy in that massless, force-free state as *radiant energy*. Note that radiant energy is not **E**-field energy or **B**-field energy, because the **E** and **B** are *force fields* (actually, force field *point intensities*) rigorously defined only in charged mass and not in free space. Radiant energy is the *force-free field energy in space*, and may consist of either positive or negative energy or a mix of both. In short, the invention deliberately engineers the *precursor force-free fields*—which are naught but curvatures of space and simultaneously asymmetries in the local virtual particle flux of vacuum—prior to their interaction with charged mass to form force fields **E** and **B** in said charged mass.

Changes of radiant energy do change the energy density of the local vacuum and of local spacetime; hence, they directly and simultaneously alter the local vacuum dynamics as well as the local spacetime curvature dynamics. Changes of radiant energy in space are force-free and hence work-free, and they are more properly referred to as *asymmetrical re-gauging* {2}, already known to be work-free due to the *gauge freedom axiom* of quantum field theory—also used in gauge field theory and even to regauge the classical Maxwell-Heaviside electrodynamics for simpler equations easier to solve.

In this Section we explain these novelties as they are used in the invention, and also include the solution to the long-vexing source charge problem. This solution was derived by one of the inventors (Bearden) {36} and has been published in several refereed journals in 2000 and subsequently. The result of the invention is a novel new way to utilize electrical circuits, initiating them to rather freely receive excess negative energy from their active vacuum and curved spacetime environments, utilize impedances as amplifiers, transduce the received negative energy into positive energy by quick-charging capacitors and batteries with the negative energy, and then utilize this excess positive energy for useful purposes such as powering electrical systems and their loads.

The result of the free interchange of energy between the active environment and the circuit or system is to provide (i) the free input of excess negative EM energy to the circuit from said active environment(s), and (ii) transduction of the excess EM negative energy into normal stored EM positive energy, thence dissipating said excess positive energy in loads, allowing COP > 1.0 operation analogous to that of a common heat pump. Also, by including the small input positive energy—necessary to initiate the negative energy entry—as part of the system output load, the invention accomplishes controlled positive feedback and (ii) allows COP = ∞ in the manner of a solar cell array in its external solar radiation environment, wherein according to the invention all positive energy dissipated as system input, output, or losses actually is received from the

vacuum in the form of negative EM energy. Again we accent that, even in a solar cell, it is unknown but true that the energy from the spacetime environment is in field-free precursor form, and only becomes “EM force field energy” when said entering precursor energy interacts with charged mass in said solar cell.

All sections of a circuit that alter the electron mass current thereby affect and alter the effects of the precursor energy’s interaction with the charged mass. In short, one can manipulate all parts of a circuit (other than a theoretically perfect conductor section without impedance whatsoever) so as to manipulate the precursor radiant energy interaction with charged mass, to further form additional EM force field energy in the circuit. This is a totally different function and capability than has previously been advanced in any other invention.

*Positive energy flow* encountering an impedance element in a circuit encounters positive impedance (such as the notion of positive resistance or positive resistor), resulting in energy outflow losses. *Negative energy flow* encountering an impedance element in a circuit encounters *negative impedance* (such as the notion of negative resistance or negative resistor), resulting in energy inflow gains. The excess negative energy inflowing into the impedance regions of a circuit comes freely from the external environment. This effect is herein called “environmental amplification” or “E-amp” for short. Therein lies one of the greatest discoveries and applications of the invention. We explain further:

*Positive energy flow* is innately *divergent* (or scattering) away from the line of flow and into the external environment, outward and away from the line of propagation. Accordingly, a pure conductor must act as an inverse waveguide to “hold the energy in” along the line of propagation down the conductor, in order to prevent the divergence and scattering of the energy out of the system and into the external environment as *system losses*. Any impedance in the circuitry path reduces the conductance and thereby reduces that “holding in”, and so in fact diverges and scatters some of the flowing positive energy out of the system, thereby generating the *system losses*. Positive energy flowing through real circuitry (which will have some impedances) *a priori* has some of the energy diverged or lost from the flow and scattered out into the environment. Hence less positive energy flow is output by the system as useful work, than is input to it from all sources.

*Negative energy* is innately *convergent* (or inflowing) from the external environment into the propagation path, and the conductor must act to “hold back the excess negative energy inflow” that is constantly trying to inflow from the external environment. Any impedance in the propagation path through the circuitry will reduce that “holding back” of the negative energy trying to inflow from the external environment. Negative energy flowing through circuitry with successive impedances has additional negative energy additions that inflow from the external environment at those impedances. Hence more negative energy flow is output by the normal system circuitry than is input to it by the “design input” point or section—the excess being freely furnished by the E-amp effect.

By using the negative energy output to charge a proper accumulator (such as a capacitor or battery), it is changed into positive energy. The positive energy storage can then be dissipated to produce more useful work than the energy input by the operator—the excess energy having been freely received from the active environment. In a positive energy system, the system dissipates energy into the active environment. In a negative energy system, the environment dissipates negative energy into the system.

To increase the available flow of positive energy through a real system, one reduces the serial impedance(s) of the system. To increase the available flow of negative energy through a real system, one increases the serial impedance(s) of the system.

The invention exploits this property in a novel manner by deliberately causing negative energy to interact with impedance circuit elements. It thus amplifies flowing radiant energy by creating conditions that stimulate the inflow of excess negative energy from the active external environment. The invention does this by means of asymmetrical re-gauging. According to the gauge freedom principle of quantum field theory, gauge field theory and even common electrodynamics, asymmetrical re-gauging never requires work since force is not involved. Thus, the invention achieves energy amplification via asymmetrical re-gauging, without the expenditure of work. (We discuss gauge freedom and the definition of “work” in greater detail later in Section I.)

So a novel feature of the invention is its special use of all impedance sections—capacitive, inductive, and resistive sections—of normal circuitry as *negative energy flow amplifying sections* or “E-amp” sections, thereby further increasing the input and interaction of negative energy into the system from the local vacuum environment.

In this manner most of the circuitry of the invention functions as a series of negative impedances, each further amplifying the available negative energy flowing in the system and available for charging batteries or capacitors. The charged batteries or capacitors then transform the collected negative energy into positive energy.

In addition to the inductive and resistive sections of the system, this novel feature of the invention includes the altering of the local vacuum inside a capacitor or battery being charged by the process, so that a further amplified entry of negative energy into the system occurs from this localized region of the vacuum inside said capacitor or battery.

Figures 17-25 are provided to illustrate the conceptual material of Section 1: Background Information. Figures 26-35 further illustrate the invention in detail.

Figure 17 on p. 37 shows the relationships of the three components of the supersystem; Figure 18 on p. 38 shows that the standard electrodynamics and electrical engineering model assumes away the active vacuum and active curved

spacetime of the supersystem, thereby assuming away the very functions and processes that the present invention initiates and applies; Figure 19 on p. 38 shows  $COP < 1.0$  operation of a normal electrical power system; Figure 20 on p. 39 shows the operation of a solar-powered electrical power system in  $COP = \infty$  mode. Figure 21 on p. 39 shows the two-reservoir representation of the common home heat pump's operation. Figure 22 on p. 40 shows the diagrammatic operation of the invention in  $COP > 1.0$  mode; and Figure 23 on p. 40 shows the diagrammatic operation of the invention in  $COP = \infty$  mode. Figure 24 on p. 41 shows a mechanism for amplification of negative energy flow in impedance sections, for sharp gradients. Figure 25 on p. 41 shows typical circuit elements that have impedance and exhibit amplification of negative energy flow, for sharp gradients.

### 1.1. On Radiant Energy—Its Nature and Novel Characteristics

#### 1.1.1. Flaws in the Electrical Power Engineering Model

Figure 17 shows a supersystem model, which more accurately depicts how nature is organized. Figure 17 also shows the interactions between vacuum, curved spacetime, and physical system that do occur. The supersystem consists of (i) the physical system and its dynamics, (ii) the active local vacuum and its dynamics, and (iii) the active local curvatures of spacetime and their dynamics. (“Dynamics” as used herein generally refers to some pattern of changes over time.) The physical system and its dynamics are **observable**. The other two supersystem components—the active local vacuum and its dynamics and the active local curvatures of spacetime and their dynamics—are **not observable**. In the supersystem model, “cause” arises from the two nonobservable components; the familiar observable changes in the physical system reflect the “effects”.

Now compare Figure 17 to Figure 18. Figure 18 shows that the standard electrical power engineering (EPE) model assumes a *flat local spacetime* and an *inert vacuum*. Flat local spacetime has been falsified by general relativity since 1916. Inert vacuum has been falsified since the 1920s by particle physics. Moreover, EPE assumes no input of negative energy; this can also be a false assumption, since negative energy has been known in physics (but misused or not used at all) since Dirac's theory of the electron in 1928-1930. These three erroneous assumptions eliminate from the EPE model any effects of the local standard environment. In short, EPE severely mutilates the *supersystem* {3} of Figure 17, erroneously assuming no extra energy can be received via re-gauging.

Nevertheless, all changes to the observed physical system and its dynamics actually do result from the ongoing interactions between the physical system (i) and the nonobservable supersystem components (ii and iii).

The *entropic* EPE model thus assumes away the precursors of force, and thus assumes away the possibility of engineering those precursors. Hence it assumes away a whole technology, *negentropic engineering*. The present invention is

perhaps the first invention to deliberately evoke and utilize just such *negative entropy engineering*, a major technology that has been neglected and bypassed by science since the beginning.

The EPE model thus focuses on the system and its observable (effects) dynamics, and depends for its applicability on Lorentz symmetrical re-gauging of the Maxwell-Heaviside equations, as self-enforced by the ubiquitous closed current loop circuit. In short, the EPE model is useful and describes nature with sufficient approximation only when the *net* negentropic effects of supersystem component interactions are made negligible. Its great disadvantage is that it foists COP<1.0 EM systems upon the world community, always thirsting for combustion of fuel, consumption of fuel rods, etc. and causing the great disruption and poisoning of the planet with energy byproducts and resultants.

### 1.1.2. Vacuum/Empty Space Is Highly Energetic

Contrary to usual electrical power engineering, in modern physics empty (mass-free) space (which includes the active vacuum) is a very energetic and dynamic medium. It has to be, since it contains the set of all causes and their dynamics—the causative dynamics which when interacted with mass will and do generate all observed forces and all observed changes in the physical system! Any change in the vacuum, whether a force field, potential, wave, or energy flow movement (energy flow) thus involves the dynamics of this vacuum medium itself. As Davies expresses it {4}:

*“What might appear to be empty space is, therefore, a seething ferment of virtual particles. A vacuum is not inert and featureless, but alive with throbbing energy and vitality. A ‘real’ particle such as an electron must always be viewed against this background of frenetic activity. When an electron moves through space, it is actually swimming in a sea of ghost particles of all varieties – virtual leptons, quarks, and messengers, entangled in a complex mêlée. The presence of the electron will distort this irreducible vacuum activity, and the distortion in turn reacts back on the electron. Even at rest, an electron is not at rest: it is being continually assaulted by all manner of other particles from the vacuum.”*

In terms of spacetime curvature, Evans expresses it beautifully {5} as follows:

*“In standard Maxwell-Heaviside theory, the electromagnetic field is thought of as propagating in a source-free region in flat spacetime where there is no curvature. If, however, there is no curvature, the electromagnetic field vanishes ... empirical evidence refutes the Maxwell-Heaviside theory.”*

*“In general relativity, if there is mass or charge anywhere in the universe, then the whole of spacetime is curved, and all the laws of physics must be written in curved spacetime, including, of course, the laws of*

*electrodynamics. Seen in this light, the  $O(3)$  electrodynamics of Evans and the homomorphic  $SU(2)$  electrodynamics of Barrett are written correctly in conformally curved spacetime, and are particular cases of Einstein's general relativity as developed by Sachs. Flat spacetime ... [as assumed in classical  $U(1)$  electrodynamics]... as the description of the vacuum is valid only when the whole universe is empty."*

This invention utilizes energy in the *radiant, mass-free, force-free form* that energy takes in space (in the virtual particle flux of the vacuum and curvature of spacetime) prior to its interaction with mass (prior to observation) to form force. The invention uses both EM positive energy and EM negative energy, with special emphasis on the use of EM negative energy. The invention operates in the nonobservable *virtual state* (causative) energy realm as well as in the *observable state* (mass system effects) energy realm. Specifically, the invention operates in and upon the *precursors* that generate forces in and of charged masses. It operates and functions in that area where net negentropic mutual interactions of the three supersystem components *need not be and are not negligible*, but to the contrary are eagerly sought and maximized.

### 1.1.3. Modern View of Force

Mass is a component of force, by the definition  $F \equiv dp/dt$ , where  $p = mv$ . There are no force fields in mass-free space, contrary to the assumptions of classical EM that such force fields do exist in empty space. The "force field in space" notion was a result of the original Maxwellian assumption of the material ether, so that mass was thought to be everywhere present. In that case, the "force field in space" would be the force field in material ether. The equations assumed this and still do, since they were never changed after the Michelson-Morley experiments destroyed the material ether prior to 1900.

Modern particle physics already treats all forces of nature as being generated by the interaction of virtual particle flux upon observable mass and charge, and therefore generated by interaction of a precursor. The force prior to observation is *that ongoing 4-space interaction of 4-space precursor and 3-space mass*. The virtual particle flux with its dynamics (and its associated curved spacetime dynamics) is the *causative precursor* to force and force field. The activity of the virtual particle flux of the vacuum is a known precursor to generating force itself, in and on the mass with which it interacts. Once the forces are generated, the *changes* caused by the forces to the observable mass and observable charge are measurable, but *not* the causative virtual particle flux dynamics (the active precursor causes) themselves. Observed force is an *effect* of the precursor interactions with mass and charge. *Only effects are observed, not primary causes*.

The precursors themselves can be directly engineered and manipulated, *before* they have interacted with charged mass, and then interacted to create *freely altered* forces and force fields  $E$  and  $B$  (and  $D$  and  $H$ ). This is actually a

previously unrecognized principle of nature: *Forces may be manipulated and engineered in force-free fashion by directly manipulating their force-free precursors*. This manipulation may be considered *re-gauging*. It is work-free under the gauge freedom law of physics.

In this invention, the precursors are freely engineered (i.e., work-free) by simple re-gauging and then allowed to interact with masses to produce altered forces that do actual work. Thus, *useful work can now be produced with free re-gauging energy, and with little or no energy directly furnished by the operator himself*. There is no “conservation of work” law in nature; instead, there is a conservation of energy law. Work is *change of form* of energy; it is not *change of magnitude* of energy. Instead, all the energy necessary to perform the work (i.e., to have its form changed) can be received by the system from the engineered precursors in the local vacuum and/or local curvatures of spacetime. The invention is in fact the first concrete and practical step in real EM systems along the direction of *vacuum engineering*, envisioned by Nobelist Lee {6}. In that sense the invention is a pioneering invention.

An EM circuit or system in fact requires a unified field theory for analysis. Quoting Evans {7}:

*“This fundamental result of differential geometry implies that electromagnetic energy can be transmitted from a source to a receiver by scalar curvature  $R$ , and that electromagnetic energy is available in non-Euclidean spacetime.” “All fields in nature are fundamentally dependent upon, and originate in, scalar curvature  $R$ .” “The charge obtainable from a given curvature  $R$  in a given volume is about twelve orders of magnitude greater than the mass obtainable from the same curvature  $R$  for the same volume.” “..[The] ... electromagnetic energy from non-Euclidean space-time is available to the Earth-bound engineer in usable form, and originates in the curvatures inherent in the rest of the universe.” ... “... the charge and concomitant electromagnetic energy available from curvature induced by mass is amplified by about twelve orders of magnitude.”*

In the invention, the input energy is largely received in the form of *negative* energy, so much of the heating, friction, fuel-consumption, etc. that accompanies presently utilized mechanisms for energizing working systems (with positive energy) can be eliminated, particularly as the technology of this invention is steadily developed.

As shown by Einstein, Wheeler, Evans and many others, modern general relativity treats the forces of nature as being generated by local curvatures of spacetime interacting with observable mass and charge. Energy *identically* is curvature of spacetime. Further, change of magnitude of energy and therefore change of curvature (i.e., re-gauging) is *work free* since change of spacetime curvature is simply re-gauging. Curvature of spacetime is taken as the *precursor*

that interacts with mass to generate force in and of mass systems. The changes to the observable mass and observable charge are measurable, but the causative curvatures of spacetime themselves are not measurable. Only effects are observed, not causes. Again, the curved spacetime precursors are directly engineered and manipulated by the present invention, before they have interacted with charged mass to create forces and force fields **E** and **B** (and **H**). Hence the energizing or potentializing process for working systems has been fundamentally altered to mostly employ a direct application of gauge freedom.

Precursors and their dynamics—directly engineered by the invention—rigorously are *what energy identically is*. As we discuss later, this is actually the first formal and testable definition of energy itself, and *the invention therefore is a new method for directly engineering causative energy itself*. Since in any local curvature induced by local mass there is some twelve orders of spatial energy greater than the energy locked in the mass itself {7}, then in a local system or device there is no shortage of the available spacetime curvature energy available to be “precursor engineered”.

Herein we refer to this “precursor” or enormous basic EM energy of curved spacetime as *radiant energy*. A given exact pattern and dynamics of radiant energy will also be referred to as a “causative engine” or just as an “engine” where it is understood that a non-material “asymmetric gauge freedom engine” is being utilized.

For any physical system and its forces and functions—any whatsoever—there is an exact and specific engine interacting with the masses of that system (at every level) to generate the forces at every level that drive the dynamics of said physical system at all levels. The invention is believed to be the first to deliberately engineer and manipulate the precursor engine itself—in this case the engine of an electrical power system—so that the power system becomes a COP >1.0 power system without the operator himself having to pay to furnish the excess energy. Instead, the environment (spacetime and virtual particle flux of the vacuum) is freely engineered or “specifically regauged” to freely furnish the extra potential energy to the working power system via a form of free re-gauging.

It follows that, by deliberately manipulating the precursors—the virtual particle flux itself (which also simultaneously manipulates the local curvature of spacetime itself)—then the future force(s) subsequently developed on a mass or charge by the interaction of that manipulated virtual particle flux is(are) also being engineered *in advance* and for free. The *causes* are being directly manipulated and engineered, not the effects. Directly (freely) changing the precursor causes also changes their subsequent interactions on the physical system to produce observed (real) physical effects such as the forces driving the system.



A system exhibiting forces is actually existing in a noninertial frame, thus in a precursor engine of curvatures of spacetime and altered virtual particle fluxes of the vacuum. Hence the most direct form of engineering is to directly and asymmetrically engineer the precursors themselves. The reason is that *such engineering is force-free a priori*, and therefore requires no  $\int \mathbf{F} \cdot d\mathbf{l}$  work (or, in the real world, requires only a little work for switching and control). One merely alters “patterns of potential energy”, which is a set of specific asymmetrical re-gaugings and therefore free under the well-known gauge freedom axiom of physics. The invention expands and “makes concrete” the very notion of “re-gauging” and “gauge freedom”. The invention also significantly expands the very concepts of “power system engineering” and “electrical power production”.

#### 1.1.4. Engineering the Effects Versus Engineering the Causes

The conventional engineering method is to assume use of *given observable effect forces* to further manipulate observable mass and charge and their concomitant fields. The invention, however, manipulates the *nonobservable causative (precursor) agents themselves* (virtual particle flux and curvature of local spacetime) in a “pre-engineering” operation, thereby freely altering the forces that the altered causative agents will produce in their subsequent interactions with the mass system. It appears that no such direct manipulation of the *pre-force* or force-field-free precursor agents in space (i.e., spacetime itself and the virtual particle flux of vacuum itself) has been previously utilized in electrical engineering, battery charging, or powering electrical systems—or for that matter, in any other field of engineering.

Contrary to an elementary physics book, mass is a *component* of force, and this has long been known to leading physicists (such as Feynman, Wheeler, etc.). There is no force without the interaction of a non-mass causative agent (curvature of spacetime, or virtual particle flux of the vacuum) and a mass. In short, force consists of (i) the causative agent, (ii) the observable mass or charge, and (iii) the ongoing interaction of the two. Thus “force” identically is (and reveals) *the presence of an ongoing force-free fundamental re-gauging process acting on a mass or charge*. It has no existence at all without the presence and interaction of all three items: (i) the active force-free precursor, (ii) mass and/or charge, and (iii) their ongoing interaction. This allows an answer to the problem posed by Feynman as to the unfathomable nature of force, when he stated {8}:

*“One of the most important characteristics of force is that it has a material origin, and this is not just a definition. ... If you insist upon a precise definition of force, you will never get it!”*

Feynman’s dismay is because the conventional mechanics notion of a separate massless force acting upon a mass is *totally false*: There is no such thing as a “massless force”, because the phrase itself is an oxymoron. However, now force *does* have a precise definition, once the *supersystem* dynamics are considered and not just the *system* dynamics. Force may be precisely defined as the

presence of an engine interacting with a mass (including charged mass) to produce changes to said mass or charged mass, including all the masses and/or charges of a system.

As an ongoing process, the “production of force” process is subject to *direct, work-free pre-engineering of its non-mass causative precursor component*. Changing the non-observable causative component does not necessarily require work, because no observable load is being affected or “powered”. Also, no force yet even exists, so precursor engineering does not involve work  $W$  from translating the ongoing force process  $F$  through distance  $S$ , via the equation  $W = \int F \bullet ds$ .

Thus, the accepted principles of gauging and gauge freedom are applied and extended to allow a powerful and novel “pre-engineering” capability using deliberate combinations of asymmetrical re-gauging. The work-free energy is indeed changed freely, but conservation of energy is rigorously obeyed because the excess energy is freely received from the active environment {9, 10}.

In the modern physics view, the hoary mechanics notion that a separate *massless* force field in space acts independently upon a separate mass is false, since the term “massless force field” is an oxymoron *a priori*. As is well known in foundations work, no *force field* exists as such in empty space, from first principles. As Feynman states {11}:

*“...in dealing with force the tacit assumption is always made that the force is equal to zero unless some physical body is present... One of the most important characteristics of force is that it has a material origin...”*

Jackson {12} in fact is aware of this fact in classical electrodynamics, and states how it is ignored by electrodynamicists. Quoting:

*“Most classical electrodynamicists continue to adhere to the notion that the EM force field exists as such in the vacuum, but do admit that physically measurable quantities such as force somehow involve the product of charge and field.”*

Although most electrodynamicists ignore it, for some decades foundations physicists such as Feynman have been aware that the field in space and the potential in space are force-free *a priori*. Hence changing them is or can be work-free also, being mere *asymmetrical re-gauging*. The standard gauge freedom principle of physics guarantees this work-free engineering capability to affect and change at will the precursor to force, hence changing the precursor to the production of work as force translated through a distance.

Note that force-free engineering of the precursors (the active vacuum and curvatures of spacetime) is *negentropic*. That is, no work is done, and an additional ordering of some volumetric energy is achieved. This re-gauging (changing the *magnitude* of the local energy, though not its *form*) by disequilib-

rium energy flow is work-free and permissibly violates the present statement of the second law which requires equilibrium. Also, the re-gauging requires a slight correction to the present first law of thermodynamics, which has heretofore been incorrectly stated. Work rigorously is the change of *form* of energy, not the change of *magnitude* of energy as is assumed by the first law for change of an external parameter of a system such as its potential (and potential energy). The first law thus requires this slight correction, since as presently written it specifically prohibits re-gauging. As an example, doubling the voltage on a system where no extra current is allowed, freely doubles the collected potential energy in the system. This increase in the magnitude of an external parameter—the voltage—is work-free and is mere re-gauging, so long as the energy is input in the same form as is the external parameter. In the example, no extra power is required because no extra current is allowed, hence no extra work is required.

The additional implications for thermodynamics are intense. This “work-free engineering of the precursor to force and work” is the long-missing half of the present second law of thermodynamics: It allows negative entropy production and engineering as force-free and work-free engineering of the precursors to the forces and force fields in affected matter. We have previously shown the source charge’s total violation of the second law of thermodynamics, and we include a necessary restatement of the second law in this paper.

The overly restrictive classical second law is already under intense attack and falsification—theoretically and experimentally—by leading thermodynamicists anyway {16,37,40}. That work is briefly summarized and referenced in this section. Further, thermodynamics is recognized to have a fundamental time asymmetry problem {38}, due to the overly restricted second law which presently permits only positive entropy  $\Delta S \geq 0$  for a given system as time passes. That is falsified by every charge in the universe, which continuously produces negative entropy  $\Delta S < 0$  in accordance with the proof by Evans and Rondoni {16} that in theory such systems are possible.

Hence, one of the novel things involved in the invention is the permissible violation of the *equilibrium* second law of thermodynamics in somewhat ordinary-looking electrical power system circuits, using novel *far-from-equilibrium* operations that engineer the precursor energy prior to the appearance—in and on and of mass—of the resulting forces themselves.

What has been achieved is this: Force, so long regarded as primary in engineering, is not primary after all. Instead, asymmetrical re-gauging and engines are primary, since engineering them is work-free, yet such engineering freely alters the subsequent forces that are produced in the system and that perform dynamics and work.

#### 1.1.5. Difference Between Field and Field Intensity

Feynman also stated it even more clearly {13}:

*“We may think of  $E(x, y, z, t)$  and  $B(x, y, z, t)$  as giving the forces that would be experienced at the time  $t$  by a charge located at  $(x, y, z)$ , with the condition that placing the charge there did not disturb the positions or motion of all the other charges responsible for the fields.”*

However, as previously stated, neither  $E$  nor  $B$  in space is a force field, contrary to the assumptions of the EPE model. In fact, neither  $E$  nor  $B$  is “the volumetric field” in space or in mass. Instead, in electrodynamics  $E$  and  $B$  in space are actually the *point intensities* of the associated volumetric fields, as determined by reaction cross section of a unit point static charge, once charge and mass are physically present. Simply check the standard textbook definition of the fields. When a unit point static charge is placed at a point in the field, what gets scattered from the field is assumed to determine the *intensity of the field at that point*. Similarly for the potentials  $\phi$  and  $A$ : The  $\phi$  and  $A$  actually used in the models are not “the” potentials per se, but only an indication of their respective *point intensities* as determined by a unit point static charge. For magnetic fields, of course, a “unit point north pole” is in fact a unit point magnetic charge.

#### 1.1.6. Definition of Force

As can be seen from Feynman’s cogent statement, if the charged mass—being operated upon in a force—is removed, there is no force remaining, even though the mass-free fields (and their intensity) are still present. The field as it exists in space has no observable mass, and hence no observable force. The fact that mass is a component of force can further be seen from the definition of force  $F$  as

$$F \equiv \frac{\partial p}{\partial t} = \partial / \partial t(mv) = m \frac{\partial v}{\partial t} + v \frac{\partial m}{\partial t}$$

As can be seen, both terms of the rightmost expansion include a mass term. Hence mass is a component of the nonrelativistic part of force  $F$  and the rate of change of mass is a component of the relativistic part of force  $F$ .

We repeat that electrodynamicists and electrical engineers do not actually calculate “the”  $E$ -field or “the”  $B$ -field *as such* anyway, but only the point intensities of their constituent energy flows {14}, as determined by an interacting unit point static charge assumed to be at every point in space occupied by the field or potential. The point intensity of the EM energy flows comprising a single field or a single potential is most certainly not “the field” or “the potential” itself, nor is it the *magnitude* of “the potential” or “the field”. However, most professors and electrical engineers simply use the common corrupted jargon and speak erroneously of “calculating the field”, and “the magnitude of the field”, without accurately pointing out that only the magnitude of the *point intensity* of the field in a precisely limited type of interaction with charged mass is being calculated, not the magnitude of “the field” itself. Both the field and potential are in fact sets of EM energy flows (longitudinal EM waves) as shown by Whittaker {14} in 1903 and 1904.

As a trivial example, from any fixed static nonzero field  $E$ , any amount of “force”  $F$  can be generated or collected on charges  $q$ , by the simple equation  $F = Eq$ . All one needs is sufficient collecting charges  $q$ , to obtain any amount of force  $F$  desired from a given  $E$ .

Similarly, from a given nonzero potential difference  $V$ , any amount of EM energy  $W$  can be collected upon charges  $q$ , by the simple equation  $W = Vq$ . The real reason such equations exist and are proper is that the “isolated charge” in classical electrodynamics is not isolated at all, but—in particle physics and quantum field theory—involves two infinite charges, two infinite energies, and their exchange. So from two associated infinite energy sources, obviously one can draw as much finite energy as one desires.

Aspects of the present invention which take radiant energy, in negative energy form, directly from the earth itself, from a tree, etc., show that copious energy can be collected and received from very small potential differences. These aspects will demonstrate that such energy collection can be done by varying the example parameters, receiving the energy in negative energy form, freely amplifying the negative energy in system impedances, and transducing the negative energy to normal positive energy.

#### **1.1.7. Radiant Energy Engineers the Cause Rather than the Effect**

Again, we shall speak of field or potential energy in its mass-free, force-free, spatial form, prior to observation, as *radiant energy*. In that sense, radiant energy engineering has to do with engineering the dynamics of the curvatures of spacetime itself (general relativistic view), or with engineering the dynamics of the virtual particle flux of vacuum itself (particle physics and quantum field theory view). *Both precursors* are engineered simultaneously by the invention, since a change in one changes the other also. The freely re-engineered precursors then interact with charged mass to generate real forces, which can be very powerful and dynamic, yet initiated by very miniscule control and switching energy during the precursor engineering phase. The reason why a miniscule quantity of control and switching energy furnished by the operator is able to obtain large forces able to do great amounts of work is that the invention’s special circuitry uses the miniscule quantity of energy to create the conditions enabling the collection of larger quantities of energy from the environment. Even that miniscule quantity of initiating energy can then be taken from the system’s positive energy output, by use of clamped and governed positive feedback. In that case, the system is said to be “self-powering”; actually it is powered completely by energy freely received from the external active environment.

By dealing with the radiant energy of the causative field or potential existing in space (and in the virtual particle flux of the vacuum) prior to observation (prior to interaction with mass), the invention works directly with and on the massless forceless field itself, before real force has been produced in a subsequent

interaction of the field's intensity with mass. The invention thus interacts with and processes the nonobservable "causative" massless field and the causative massless potential themselves. The invention is thus a "causative engine" as defined previously herein.

Nevertheless, when one changes the force-free field without work, one has changed the subsequent work that the field will generate when it later interacts with the charged mass of the physical system. Again, energy is conserved, but work alone need not be conserved. There is no "conservation of work" law in nature { 15 }; instead, only the energy need be conserved. The entire radiant energy approach is to get the environment to freely furnish the necessary energy—or most of it—in advance, thereby changing the energy of the fields and thus changing the fields themselves, prior to their interaction with mass to produce work in the system.

In short, this is the mechanism for producing a special kind of nonequilibrium steady state (NESS) supersystem—one in which the active vacuum environment (and local curvatures of spacetime) furnish all or most of the excess field energy and potential energy that appears in the system. Thermodynamically, a NESS system is theoretically permitted to exhibit continuous negative entropy in the physical system itself { 16 }, while rigorously obeying the conservation of energy law. The excess ordered energy is furnished by the pre-force *active vacuum flux environment*. This radiant energy process is also the major mechanism for directly engineering the active environment (active vacuum and curvatures of local spacetime) itself—carrying out Nobelist Lee's insight { 17 } that someday a future technology might somehow enable direct engineering of the vacuum.

Further, force is an observable (because it includes change in the state of observable  $m$ ) { 18 }. Force is an effect of a more fundamental ongoing process—interaction of the vacuum and curved spacetime with mass and charge. Force does not exist as such in empty space prior to the observation—in accord with Nobelist Feynman's succinct explanation { 13 }. *Radiant energy engineering* is a method for freely changing the pre-force causative agent. The agent then interacts with charged mass to produce changed EM forces.

It is appropriate to recognize that there has previously been no adequate definition of "energy". As Feynman bluntly states { 19 }:

*"It is important to realize that in physics today, we have no knowledge of what energy is."*

From the viewpoint of radiant energy, local energy is any change in the local virtual particle flux of the vacuum, or any change in the curvature of local spacetime. It therefore is any change in the *precursor to force*, whether or not the precursor interacts with mass and charge to produce force and work. Immediately one notes that this first formal definition of energy includes both positive energy and negative energy; a spacetime curvature may be either positive or negative, and the flux of vacuum may increase or decrease in

intensity. “The field” and “the potential” are volumetric (regional) changes in the local virtual particle flux of the vacuum, as well as regional changes in the curvature of local spacetime. Again, neither  $E$  nor  $B$  are actually *fields* per se; instead, they are *point intensities* of the fields, based on a static reaction cross section assumption.

An example of radiant energy engineering is the universally accepted *asymmetrical re-gauging*, where the potential (and thus the potential EM energy) of a system is freely changed, in accord with the gauge freedom principle of quantum field theory used by all electrodynamicists. Gauge freedom (including asymmetrical freedom as well as symmetrical freedom) {20} is equivalent to the statement that no work is done when only the voltage (potential, and thus potential energy) of a circuit is changed without concomitant current flow occurring in the circuit. Voltage is not work, and change of voltage alone also is not work and does not require work.

As Davies states {21}:

*The gauge transformations in ... [electrodynamics] ... correspond to changes in ‘voltage’ from place to place.”*

As previously stated, re-gauging is work-free. By re-gauging, one does not have to “furnish all the energy” itself to the system oneself! Instead, the active environment is happy to furnish all the energy one requires, if one asks politely and properly.

We also recognize that EM field energy and EM potential energy in nature exist as *ongoing flow processes*, as shown by Whittaker in two papers in 1903 and 1904 {14}. That is, any EM field and any EM potential can be decomposed in Whittaker fashion into internal sets of bidirectional longitudinal EM wavepairs and differential functions of these sets. The volumetric field and potential themselves are actually *comprised of* hidden EM energy flows, hence *identically are* sets of such hidden flows.

Again, this explains one of the simplest but puzzling thermodynamic facts in EM theory: By changing the amount of charge  $q$  available, any desired amount of EM potential energy  $W$  can be collected from a given, fixed EM potential (say, of intensity  $\phi$ ) from a single fixed source, on charges  $q$ , by the simple equation  $W = \phi q$ . If the collecting charges are static, no work is done in collecting as much energy as one wishes, from any finite static potential. Even from a small and fixed nonzero electrostatic scalar potential, one can collect as much energy as one wishes, given that one has enough collecting charges. The mere collection of the potential energy is *asymmetrical re-gauging*. It involves energy transfer only, and it is work-free thermodynamically.

Similarly, given an unlimited availability of  $q$ , any desired amount of EM electromotive force  $F$  can be collected from a given, fixed EM force-free field (say, of intensity  $E$ ) on charges  $q$ , by the equation  $F = Eq$ .

Now either one accepts those experimentally verified and well-known simple EM equations, or one practices dogma rather than science. The equations tell us very clearly that from a single 12-volt battery one can obtain and collect all the *potential energy* and *potential energy flow* one wishes, and the energy can freely be transferred into a receiving charge system such as a special receiving circuit. Mere collection of a huge amount of energy from the continuous energy flow represented by the potential does not involve work. It has nothing at all to do with the ampere-hours of the battery, etc. It simply has to do with having enough receiving charge that interacts with that 12 volt potential flowing onto the receiving circuit and potentializing the charges. Of course, one must strangle the current! The flow of current is directly part of power, which is the rate of performing work, which is the rate at which collected energy is being *dissipated* by the circuit! Current  $I$  has nothing to do with the collection of EM energy *into* the circuit! It has to do with the dissipation of collected energy *from* that circuit.

Obviously, something that is done in ordinary circuits ubiquitously negates this innate unlimited energy collection ability permitted by nature. That “something” is the use of the closed current loop circuit. Closing the loop is symmetric re-gauging. Symmetric re-gauging is what continually destroys the dipolar source of the potential energy. *The radiant energy engineering principle is that the primary dipolar physical source of potential energy flow should not be connected into the common ground of the receiving and load circuit when appreciable current is flowing in the “powering” mode. Instead, the potential energy should be transferred from the source to the receiving circuit separately, in energy transfer (asymmetric re-gauging) mode only.*

Then the external dipolar source should be physically disconnected, at least from the common system ground, and the receiving circuit simultaneously revised to connect the load, free the now-potentialized electrons, and allow the current to flow. In that way, free potential energy collected by the “statically” receiving circuit via gauge freedom is then dissipated by the separated “dynamic” circuit to power the loads and losses. *None* of the collected energy is dissipated to destroy the primary source dipolarity.

Further, ideally the input energy should be in negative energy form, so that every element of the circuit having impedance acts as an amplifying “negative impedance” or “E-amp” to cause much more negative energy influx from the local active environment.

Then the negative energy should be transduced by the receiving circuitry so that normal powering of loads can then be accomplished, with a little switching.

Combining, there are two parts to the *radiant energy engineering principle*: a static part and a dynamic part. The static principle is:

*Potentialize statically, depotentialize (dissipate) dynamically.*



By potentializing statically onto a substantial quantity of charge, even a small voltage can produce large amounts of collected EM energy in the receiving circuit. Then by freeing the charges to flow as current, power appears. Potentialized current is driven through the load, dissipating that potential energy dynamically in the load (but with the original small voltage source disconnected).

The dynamic principle is:

*Potentialize dynamically by very sharp pulses so that negative energy inflow is copiously and freely produced. Direct this augmented negative energy pulse to a capacitive collector through a momentarily isolated circuit containing impedances, where the impedances act as negative energy amplifiers with excess energy furnished by the immediate altered vacuum and curved spacetime.*

The isolation of the dynamic sharp gradient is achieved via manipulating the grounding, usually by floating the ground. We will further discuss the dynamic principle shortly.

By use of the *radiant energy engineering principles*, very large loads can be powered in iterative dynamic powering cycles interspersed by intermediate work-free collection of large amounts of re-gauging energy (freely furnished by the active environment as excess negative energy inflow from the environment) in a static collecting cycle. For continuous operation, one stores the re-gauging energy in multiple collectors, and iteratively switches the collectors to serve as the actual power source of the dynamic dissipation cycle.

By the static principle, energy collection is accomplished in static, pure energy transfer re-gauging mode. Load powering is performed in a normal dynamic current mode by discharging from a collector the energy previously collected in static mode and transduced to positive energy. In this manner, energy from the completely free negative energy flow (extracted from the local vacuum) and triggered by any dipolar source can be utilized without destroying the source's dipolarity and its continuous flow of energy from the local vacuum.

#### **1.1.8. Radiant Energy Can Consist of Positive or Negative Energy or Both**

In nonlinear situations such as pulsing and sharp gradients, the Dirac Sea must be specially considered since it is essentially the nascent vacuum prior to alteration, and it is appreciably altered by strong gradients. Sharply changing the local energy density (and spacetime curvature) of the local vacuum can and will lift Dirac particles (particularly normal "positive energy" electrons) from the Sea, leaving behind the temporary presence and temporary persistence of unfilled Dirac Sea holes (negative energy electrons, in Dirac's theory). During the sharp gradient of the pulse, the Dirac Sea vacuum is made *asymmetrical* and dipolar, by separating holes from their normal occupying electrons. The

asymmetrical vacuum becomes a source of excess negative energy EM fields and potentials.

As *negative energy source charges*, the temporarily persisting holes pour out negative EM energy transduced from their vacuum interaction, thereby forming negative energy EM fields and potentials spreading in space at light speed. Since these negative energy force-free fields can and do also exist in space and can and do interact with elements of the physical EM system and circuitry, then the term “radiant energy” may include both positive energy and negative energy, including negative energy EM fields and negative energy EM potentials.

Radiant energy interaction and effects upon the physical system are thus far more complex than are specified in the EPE model. Additional physical phenomenology absent from the EPE model is present in radiant energy interactions. One strikingly unusual phenomenon commonly encountered in radiant energy engineering is the natural amplifying effect of impedances in the circuit, when negative energy from the environment impinges upon the impedances.

One purpose of the invention is to take advantage of novel characteristics of radiant energy {22} and its interactions for the direct extraction of EM energy from the vacuum (by an initial or “original” source) in energy flow form, and to utilize work-free energy transfer to collect usable EM energy in circuits via work-free asymmetrical re-gauging. Once the energy has been freely collected in the system from a given energy flow source, then that original source of potential may be disconnected, and the freely regauged (collected) excess potential energy of the circuit can be separately discharged into a load to power it. In this way, no back emf effect is generated upon the *original source of static potential* during the powering cycle, because then the original source is not even connected to the common system ground. In short, the original source of potential can be used and reused to furnish potential, without degradation.

This allows all back emf in the discharging (powering) circuit to be completely isolated from the original source of potential energy flow. Hence, no back emf work is done in this system by forcing current back through the original dipolar source of energy flow to destroy its dipolarity, thereby shutting off the free energy flow.

The invention further takes advantage of the proven asymmetry of opposite charges (therefore of any dipolarity) {33}, which will continuously extract and output usable EM energy directly from the vacuum itself {23}. The asymmetry of opposite charges has been proven in particle physics since 1957, but it still does not appear in the EPE model since that model does not even include the active vacuum. EPE also excludes the usage of negative energy charges, negative energy fields, and negative energy potentials.

The result is that the invention uses methods and processes that convert an EM system or device into a *nonequilibrium steady state* (NESS) system, for either

*positive or negative energy or both, with accent on the negative energy.* The system freely receives excess radiant energy from the altered active vacuum in virtual state form, coherently integrates that energy into real observable (and usable) EM field energy and potential energy, and then separately collects and discharges this excess observable EM energy in loads to obtain a coefficient of performance (COP) of  $COP > 1.0$ . A device using this process can permissibly exhibit far more work output than the input energy component furnished by the operator himself, since now the local vacuum environment furnishes the additional energy input component required.

By adding clamped and governed positive feedback from the positive energy system output to the operator's positive energy input section, a device using the process of the invention can also exhibit  $COP = \infty$ , i.e., so-called "self-powering", which is powering by the environmental vacuum's energy input, analogous to how a solar cell is powered by its active solar radiation environment. Again, this active vacuum powering does not appear in the EPE model or in present electrical power system engineering practice.

#### **1.1.9. Efficiency $\xi$ Versus Coefficient of Performance (COP)**

The overall efficiency  $\xi$  of the system is always  $\xi \leq 100\%$ , and conservation of energy is rigorously obeyed. The new process, however, is analogous to that of a common home heat pump, which may have an efficiency of  $\xi = 50\%$  so that half of all the total energy input to the heat pump is wasted. However, since—in addition to the operator's energy input—there is an additional input of excess energy from the environment, the common heat pump in nominal conditions has a  $COP = 3.0$  to  $4.0$ , even with only a  $50\%$  efficiency. Figure 21 on p. 39 shows the nominal heat pump operation.

The process utilized by the invention (Figure 22 on p. 40) operates in a fashion *analogous* to the home heat pump {24} except that it uses excess EM energy (particularly negative energy) freely received from the local vacuum environment. Analogous to the common heat pump, in  $COP > 1.0$  operation the invention's process thus has *two energy reservoirs*, not just one. The two energy reservoirs from which input energy is received are (i) the small amount of energy input by the operator himself and paid for by him, and (ii) the free excess energy input by the local vacuum environment.

Although it remains a process where efficiency  $\xi < 100\%$ , this two-reservoir energy input process—where one reservoir contains extra energy freely made available from the environment—permits the system in Figure 22 by the laws of physics and thermodynamics to exhibit  $COP > 1.0$  (analogous to the heat pump), and even  $COP = \infty$  (*analogous* to a solar cell in an environment of solar radiation as shown in Figure 20) {25}. In  $COP = \infty$  case, *all* the necessary input energy used by the system is furnished freely from the local vacuum environment. In that case, once the process is initiated and ongoing stably, the operator

need furnish no additional energy at all, for the process to continue and perform useful work continuously in the manner of a windmill or solar cell array.

Thus in Figure 23 on p. 40 the invention's  $COP = \infty$  (self-powering) operation is analogous to the operation of a windmill in a free wind, or a solar cell array in a solar radiation environment. Even with  $COP = \infty$ , the efficiency  $\xi$  is always  $\xi < 100\%$ . E.g., a very efficient windmill with  $COP = \infty$  may have  $\xi = 50\%$  and waste half of all the energy input to it, and a solar cell with  $COP = \infty$  may have  $\xi = 17\%$  and waste 83% of all the solar energy input to it. COP is defined as the energy or useful work output, divided by the *operator's energy input only*. If the operator inputs nothing while the environment does input all the energy, and if the machine produces any useful output at all, then the  $COP = \infty$ , regardless of the fact that  $\xi < 100\%$ . Conservation of energy is rigorously obeyed by both  $COP < \infty$  systems and  $COP = \infty$  systems, as shown by  $\xi \leq 100\%$  for  $COP < 1.0$  operation, for  $COP > 1.0$  operation, and for  $COP = \infty$  operation.

All energy that is *output* by the system as useful work and system losses is in fact rigorously *input* to the system and to the process, by the active environment. The present invention has merely applied unconventional ways to receive the excess energy from the active "virtual state energy" vacuum environment itself, rather than from more conventional environments such as the windy atmosphere, temperature of the local air in the environment, or solar radiation.

#### 1.1.10. Some Novel Characteristics and Actions of Negative Energy

Some novel characteristics of negative energy flow must be noted, particularly for impedance sections of the circuit that are independently grounded in floating ground fashion, and not tied to common bus ground in the closed current loop circuit.

As previously explained, normal flow of EM positive energy (diverging energy) directed down a resistive or impedance wire results in scattering some of the positive energy flow out into the surrounding environment, so that some of the transferring energy flow is lost (scattered) to the environment en route to the load. This wastes that scattered energy as heat, in any system where the purpose is to pass the energy on down the wire for use elsewhere in the system. Positive energy is said to be *heating* energy.

On the other hand, flow of EM negative energy (converging energy) through an impedance, such as a resistive wire, results in an exactly opposite and startling function. Reference is made to Figure 24 on p. 41. illustrating *environmental amplification* achieved by passing negative energy through an impedance. Excess negative EM energy is drawn into (converges into) the impedance from the external environment, increasing the overall negative energy flow (converging energy flow) down the wire, and *cooling* instead of heating! Hence negative energy is said to be *cooling* energy.

In other words, any impedance becomes an *amplifier* for a sharply pulsed negative energy EM input, with the extra input negative energy for the amplification being freely furnished from the simultaneously pulsed external active vacuum environment. So this amplification of negative energy pulses is accomplished as *pure re-gauging* from the altered vacuum. Further, the action is free, due to the gauge freedom principle already recognized in gauge theory and quantum field theory. Thus, an impedance, or section of a circuit containing impedance, becomes an *environmentally powered negative energy amplifier* (a true negative impedance). We have called this action “E-amplification” or E-amp. The E-amp also exhibits *cooling*, and is useful in cooling circuits or refrigeration.

In positive energy flow actions of normal electrical power engineering circuits, there is no parallel to this novel negative energy flow passive *amplification* action. Instead, positive energy circuits dissipate positive energy, dissipation being the exact opposite of amplification. One thus may regard the E-amp action as true negative resistance, for pulsed negative energy flow. Or more generally, as true negative impedance of any impedance section, for pulsed negative energy flow. Figure 25 on p. 41 shows some typical circuit and electrical power components that can exhibit the E-amp effect, e.g. transformers, coils, capacitors, various motors, incandescent lights, resistors, batteries, transmission lines, and so forth.

Through the use of strongly pulsed negative EM energy, the invention achieves *environmental amplification* of negative energy flows and their cooling effects, by circuit impedance components that would otherwise normally dissipate heat. Instead, now they concentrate additional negative energy from the environment. The excess negative energy is freely taken from the local vacuum via the “negative impedance” process (and cooling) induced by the *converging* function and behavior of pulsed negative energy flow.

Excess energy-converging and E-amplification effects exist for *inductively coupled* sections of a circuit, due to the “negative reactance” and “negative inductance” of inductors in negative energy flow. Hence an inductively coupled section of the invention—seemingly with a normal section efficiency of  $COP < 100\%$  for positive energy—may and will become an E-amp for negative energy and thereby actively produce  $COP \gg 1.0$ , utilizing the excess converging (negative) energy flowing in from the environment. *Nonetheless, energy conservation is still rigorously obeyed.* The excess negative energy does indeed enter the circuit via the negative impedance effect of the inductive coupling, from the “second energy reservoir” consisting of the negative energy of the altered local vacuum itself.

Capacitive sections strongly pulsed with negative energy also develop the environmental amplification (E-amp) effect, particularly after some hours of use in such fashion. The E-amp effect appears to gradually “condition” the immediate active vacuum in which the capacitor or capacitive element is embedded, so

that for large capacitances the E-amp effect appears gradually after a lengthy time delay of a dozen or more hours.

The strength of the E-amp effect appears to increase in the presence of sharp gradient conditions, such as sharp pulse discharges. Such strong gradients are already known to violate the second law of thermodynamics, for example {37g}, though why they do so has not previously been established. We discovered that, for a finite time during the gradient, such discharges significantly affect, alter, and “engineer” the local vacuum (and curve local spacetime as well), producing a second negative energy reservoir of substantial negative energy fields and negative energy flow. The present classical second law of thermodynamics erroneously assumes a flat spacetime and an inert vacuum—and the sharp gradient violates that assumption. Hence, the present second law fails for such situations, and a corrected statement of the second law is required. Such a corrected statement has been advanced by one of the present inventors, Bearden {26}, and it is given later in this paper.

The analysis of the present invention’s operation must thus take into account such novel effects of negative energy, the uses of which are part of the claims of the invention. These novel functions of the invention are not present in conventional electrical engineering, but are indicated as possibilities (though never before systematically exploited) in physics and forefront thermodynamics.

We now give some additional background necessary for understanding energy from the vacuum, by presenting the solution to the problem of the source charge {36}.

## **1.2. The Source Charge and Its Associated Fields and Potentials**

### **1.2.1. The Source Charge Problem**

Sen stated {27}:

*“The connection between the field and its source has always been and still is the most difficult problem in classical and quantum electrodynamics.”*

The source charge problem is rarely stated explicitly. Bunge {28} expresses it as follows:

*“In order to keep Maxwell’s second order equations and at the same time discard its advanced solutions in a consistent way one must add the hypothesis that the charged bodies are the sources of the e.m. field—a hypothesis that is taken so much for granted that it is hardly stated explicitly.”*

Further, Bunge wryly states that {29}:

*“...it is not usually acknowledged that electrodynamics, both classical and quantal, are in a sad state.”*

Kosyakov states the source charge problem bluntly {30}:

*“A generally acceptable, rigorous definition of radiation has not as yet been formulated.” ... “The recurring question has been: Why is it that an electric charge radiates but does not absorb light waves despite the fact that the Maxwell equations are invariant under time reversal?”*

Electrical power engineers have little inkling that their EM model assumes every charge in the universe continuously emits real EM energy without any EM energy input! It is little wonder that such a formidable problem with the Maxwell-Heaviside theory—total violation of the conservation of energy law by every charge and every EM field, potential, and joule of EM energy, merely by its very existence—has been expunged from the textbooks.

Until electrical engineers find—and incorporate in the EPE model—how *nonobservable* energy is input to a charge so that the charge can integrate it into real energy and constantly re-emit real, observable EM energy, they have no understanding at all of where the EM fields, potentials, and their joules of EM energy in their circuits actually come from. In short, not a single EE department presently understands what really furnishes the EM energy to an EM circuit, or where the energy comes from, or how. None ever has! Yet, the basis for the answer has been in particle physics since 1957 and the proof of the asymmetry of opposite charges.

### **1.2.2. Setting up the Solution to the Source Charge Problem**

EM radiation is emitted by a source such as a charge or a dipole. To solve the source charge problem, we first apply the quantum field theory (QFT) model where any “isolated” charge also polarizes its surrounding vacuum. Thus, the classical “isolated” source charge is actually a peculiar QFT dipolar ensemble: The bare charge in the middle is surrounded by a cluster of virtual charges of opposite sign in the seething vacuum.

In QFT both the central bare charge and the total charge of its surrounding cluster of virtual charges are infinite {31}; but to an external observer their *difference* is finite. Hence, the “externally observed” or externally measured value of the charge ensemble is that finite difference, and that difference has the sign of the bare charge in the middle. The magnitude of that observable difference is the classical textbook value of the magnitude of the observed charge of the so-called “isolated charged particle”. Again, in QFT the single charge is not isolated at all, but is an ensemble of opposite charges.

As such, the QFT ensemble comprising the classical “isolated source charge” must exhibit the experimentally proven broken symmetry of opposite charges {32,33,34}.

The associated classical “static EM field” in space surrounding a classical “fixed isolated source charge” is comprised of photons (quanta of the field). Since any photon in free space is moving at light speed, a stream of observable photons is

continuously emitted in all directions from the source charge. This continuous emission of real observable EM energy by a charge is also easily verified experimentally: Simply separate a static charge and instrumentally observe the appearance and expansion of its external field radially in all directions, spreading outward at light speed.

The so-called “static” field in space consists of photons moving at light speed! It is not a “static” entity at all, but is a nonequilibrium steady state (NESS) system. As Van Flandern points out {35}:

*“To retain causality, we must distinguish two distinct meanings of the term ‘static’. One meaning is unchanging in the sense of no moving parts. The other meaning is sameness from moment to moment by continual replacement of all moving parts. We can visualize this difference by thinking of a waterfall. A frozen waterfall is static in the first sense, and a flowing waterfall is static in the second sense. Both are essentially the same at every moment, yet the latter has moving parts capable of transferring momentum, and is made of entities that propagate. ... Causality seems to require the latter.”*

As is well-known {30}, there is no *observable* EM energy input to the source charge, and no instrument can measure any such input. Immediately one is confronted by a terrible dilemma: Either the charge freely and continuously *creates* real, observable EM energy out of nothing at all, and thereby completely falsifies the conservation of energy law, or else it must receive and transduce (coherently integrate to observable form) a continuous input of EM energy in *nonobservable* (virtual state) form.

The standard electrical power engineering model (Maxwell-Heaviside electrodynamics)—which does not consider *virtual state* energy inputs—thus has a formidable problem: It implicitly assumes that every EM field, EM potential, and joule of EM energy in the universe is and has been freely created out of nothing at all, in total violation of the conservation of energy law.

This is the “source charge problem”, recognized as the “most difficult problem in classical and quantal electrodynamics” {36}. It has been scrubbed from the classical texts for a hundred years, and today’s electrical power engineering students have little or no knowledge that the problem even exists. Even most electrical engineering professors seem unaware of this horrendous problem in their EPE electrodynamics model.

### **1.2.3. Solution to the Source Charge Problem**

Obviously one must either totally surrender the conservation of energy law, or else one must extend the classical EM model to allow *nonobservable* EM energy input to the source charge as a dipolar ensemble. *Unless such input is accounted for*, one’s model accepts free and universal creation of energy from nothing.



In short, the source charge must absorb *disordered* virtual photon energy of the seething vacuum, transduce (coherently integrate) the absorbed virtual energy into real observable photons, and re-emit real observable photons in all directions to form the associated ordered macroscopic fields and potentials. This requires that the source charge be recognized as a nonequilibrium steady state (NESS) thermodynamic system, continuously *consuming positive entropy* of the virtual-state vacuum and *producing* (transducing it into) *negative entropy* in the observable state. It thus continuously pours out real photons, thereby establishing and maintaining its associated fields and potentials.

As a dipolar ensemble in QFT, the source charge must exhibit the broken symmetry of opposite charges. *A priori*, such broken symmetry means that the input energy is received in virtual state form and results in observable energy output.

So this broken symmetry action of the source charge is a continuous negative entropy operation {37,38,39,40}, totally violating the present form of the classical second law of thermodynamics, since that form prohibits negative entropy. Evans and Rondoni {16} have shown theoretically that nonequilibrium steady state systems can produce continuous negative entropy, although they could find no known physical system that exhibited continuous negative entropy.

*It only takes one white crow to prove that not all crows are black.* It follows that exhibiting a single physical system continuously producing negative entropy (continuous recovery of entropic energy) is sufficient to overturn the present form of the second law in its entirety. Consequently, we have exhibited such a system: the source charge. Every charge in the universe, together with its associated fields and potentials, continuously produces negative entropy and totally negates the overly restrictive present form of the second law of thermodynamics. Evans and Rondoni have shown theoretical permissibility {16}, and the source charge experimentally confirms it.

The present invention is a second entire class of systems also violating the classical second law while fully complying with the laws of physics.

The second law must therefore be revised and extended, and the extended law must include negative entropy operations as well as positive entropy operations. As presently written, the erroneous second law of thermodynamics excludes every charge in the universe, every EM field, every EM potential, and every joule of EM energy. It also completely excludes free re-gauging, a proven cornerstone of modern physics.

We have previously restated an appropriate revised second law as follows {41}:

*“First a negative entropy interaction occurs to produce some controlled order (available controlled energy). Then that initial available controlled order will either remain the same or be progressively disor-*

*dered and decontrolled by subsequent entropic interactions over time, unless additional negative entropy interactions occur and intervene.”*

#### **1.2.4. Considering “Negative Energy” Charges and Negative EM Energy**

We must also consider persistent negative energy charges (such as Dirac’s negative energy electron) as source charges, producing associated *negative energy* EM fields and *negative energy* EM potentials. These slightly persistent negative energy electrons (they *are not* positrons, since they have not yet interacted with mass) are negative energy source charges producing negative energy EM fields and potentials.

Unknown to Kondepudi and Prigogine, and to other thermodynamicists, these negative energy source charges and their resulting negative energy EM fields and potentials can and do occur in strong gradient processes {42} such as Bedini’s sharp discharge pulses or spikes {43,44} and they do have a finite persistence time during such spikes if the section of the circuit they occur in has an independent “floating ground”. Hence, during their persistence they produce *usable* negative energy EM fields and negative energy EM potentials. In turn, together with the E-amp effect in circuits with adroit isolation of pulse charging section grounds, this allows a startling new negative energy mechanism for charging batteries and powering systems with remarkable power and rapidity, for very little positive energy dissipation by the operator. Even peak pulse powers of 300 KW are usable and achievable, with most of the energy being freely furnished from the vacuum environment via the E-amp effect.

In normal “common ground, closed loop” circuits, the negative energy holes are shorted directly to ground, interacting with mass in that electrical ground and changing to positrons (with positive mass and positive energy). This immediately “kills” the negative energy EM fields and potentials. Or looked at another way, in the internal vacuum energy interval between a positive energy electron and a negative energy electron, there is a continuum of positive energy EM field above the zero reference, and a continuum of negative energy EM field below the zero reference. Common grounding and closed current loop circuitry effectively blocks the use of this continuum. Floating ground in the asymmetric vacuum portion of the circuit where one deals with negative energy is essential so that the negative energy EM fields can be sustained and not extinguished.

Negative EM energy in general behaves exactly opposite to our familiar positive EM energy. Deliberate use of negative (converging) EM energy as compared to positive (diverging) EM energy allows passage of very large *converging* EM negative-energy currents through tiny wires, resistors, against back emfs, etc. This enables the use of extraordinarily powerful *negative energy EM pulses* for charging a battery (or capacitor) very rapidly. It also enables the E-amp effect, in which resistive and inductive sections serve as amplifiers immediately, while capacitive sections gradually “grow” the local E-amp effect, usually over a dozen or more hours. Note that the batteries are also capacitors, and so the

process does gradually condition the immediate vacuum environment of the batteries, so that the E-amp effect appears in the batteries also.

This negative energy and the Dirac Sea, as used in this novel battery-charging invention, trace back to Dirac's electron theory {45}. The invention deliberately utilizes a negative entropy process that transduces excess re-ordered and usable EM energy from disordered EM energy of the vacuum. It is a new field of technology, not previously considered in battery charging or in powering of EM circuits and devices or in electrodynamics itself.

### 1.3. Some Electromagnetics and Physics Background

#### 1.3.1. Introduction

The invention uses characteristics of extended (higher group symmetry) electrodynamics not present in ordinary electrical engineering texts and classical electrodynamics texts, but present in physics including quantum field theory, gauge field theory, and nonequilibrium thermodynamics. It also utilizes *negative energy* EM fields and potentials, and *negative energy* currents. Hence an overview of the process's novel electrical physics is required, as well as some history of how classical electrodynamics and electrical power engineering came to be so unreasonably restricted.

#### 1.3.2. Some Classical Electrodynamics History

Maxwell-Heaviside electrodynamics was formally initiated in a paper by Maxwell in 1865, containing his theory unifying electrical theory and magnetic theory as 20 quaternion and quaternion-like equations in 20 unknowns {46}. Another Maxwell paper {47} in 1868 is of interest; here Maxwell used an electrical derivation of his theory instead of the previous dynamical derivation. Maxwell's book (first edition) followed in 1873 {48}.

At the time there were less than three dozen scientists worldwide who could understand Hamilton's quaternions {49}—because worldwide there were only about three dozen capable electrodynamicists! Consequently, there was open scientific hostility to quaternion algebra. Heavily pressured by his publisher and peers to simplify the quaternion-like mathematics, Maxwell prepared most of a much simpler manuscript {50} that was published in 1881 after Maxwell's premature death in 1879. The second edition of Maxwell's full treatise {51} was also published after his death and incorporated severe simplifications, as did the third edition {52}.

Heaviside, perhaps the major architect of modifying Maxwell's theory, was a self-taught genius who never attended university. He was still teaching himself differential equations when Maxwell's first edition of his *Treatise* was published in 1873.

After Maxwell's death, several scientists—notably Heaviside {53}, Gibbs {54}, and Hertz {55}—dramatically reduced the equations to much simpler vector

equations, leaving the higher group symmetry quaternion algebra behind—an action Maxwell himself had also begun under pressure prior to his death in 1879. It is Heaviside's equations and notation (53c) that are taught as “Maxwell's equations” in the standard undergraduate electrodynamics texts today.

In the 1890s there occurred a short and sharp “debate” {56}—mostly in the journal *Nature*—between the vectorists and the few quaternionists such as Peter Guthrie Tate {57,58,59}. The quaternion approach was just abruptly abandoned by the oncoming electrodynamicists in favor of the new and much simpler vector approach.

The reduction of Maxwell's theory to vector algebra was a substantial reduction in topology; hence it produced a topological subset of the original Maxwell theory.

Beginning with his doctoral thesis in 1875, Lorentz further truncated the Heaviside equations arbitrarily, by *symmetrically re-gauging* them {60}, so that closed analytical solutions might be obtained and numerical methods usually avoided. This symmetrical re-gauging in fact nullifies any receipt and effective use of excess energy by a Maxwellian system from its external vacuum environment, although it implicitly assumes that the potential energy of the system is freely changed (regauged) twice by precisely such re-gauging energy freely received from its active environment.

In electrical power engineering today, the *symmetrically* regauged and highly simplified equations of classical electrodynamics are used. Every electrodynamicist accepts that the potential and potential energy of an EM system can be freely changed at will, without work. However, he also usually insists that it only be done “just so”, where *both* potentials  $\phi$  and  $A$  are changed, and where the two new free force fields that emerge are equal and opposite. That way, all the excess re-gauging energy is “locked up” as a change in the stress in the system. The excess energy is there, but it has passed into “stress energy” and is no longer available to perform *translation* work in the load.

This weird arrangement—to accept even enormous extra energy freely from the re-gauging environment, but to deliberately “lock it up” so that it cannot be put to practical use and perform useful work in the load—is an inexplicable self-imposed destruction of easily obtaining copious EM energy from the vacuum via asymmetrical re-gauging *for free*. That it continues to be universally upheld and enforced, defies the human imagination. Paraphrasing Tesla, it is “*one of the most inexplicable aberrations of the scientific mind that has ever been recorded in history*”.

This means that no free *net* force resultant—due to the excess energy freely received from the vacuum—is *allowed* to exist in the regauged circuit, to dissipate the excess free re-gauging energy by translating electrons as current and powering loads. Hence, today's electrical power systems are unable to effectively use their free extra re-gauging energy because it is always *symmetri-*

cally received from the vacuum (via equal and opposite energy flows immediately nullifying each other). If *asymmetrically* received, then the received re-gauging energy could indeed be used to freely power loads.

Note that, to even make an inert circuit work, we do have to asymmetrically apply voltage, which is an asymmetrical re-gauging. But we also are trained to employ the common-ground closed current loop circuit with the source dipole of the external generator in the loop. That way, the circuit itself ruthlessly enforces gauge symmetry, and thus makes the back emf equal to the forward emf, preventing any use of the freely received extra re-gauging energy to translate extra electrons freely and perform some free work in the loads.

So Lorentz's arbitrary symmetry limitation is self-enforced by the closed current loop circuit, which provides the two equal and opposite re-gauging forces in the form of the equal forward emf and back emf. Since the two always sum to a net  $\text{emf} = 0$ , this inane circuit cannot use its excess vacuum energy to perform free work useful to the operator. Again we are reminded of Tesla's characterization of the sheer stupidity of such an arrangement. It's rather like bringing home free groceries, locking them firmly in the pantry, and never touching them because one refuses to unlock the pantry. Small wonder then that one would have to continually pay for more groceries.

Actually, to be complete, earlier L. V. Lorenz (spelled without the letter "t") {61} had independently derived the electrodynamic equations and had also done the symmetrical re-gauging for which Lorentz (spelled with a "t") was credited while Lorenz's work was ignored. Jackson and Okun {62} have formally clarified how Lorentz was and is erroneously credited with what Lorenz had already done before him.

### 1.3.3. Theory of EM Energy Flow through Space

In the 1880s after Maxwell was already dead, two scientists—Heaviside {63,64} and Poynting {65}—independently and simultaneously developed the notion of the flow of EM energy through space, and formalized and published it. The EM energy *associated with a circuit* flows through space surrounding the conductors and outside them. The electrical current " $I$ " is not part of the energy flow equation at all, although most engineering students have significant initial difficulty comprehending this, as pointed out by Heald {66} and many others. Specifically, " $I$ " is part of the power  $VI$ , which is the time rate of performing work. Hence the current is associated with the circuit's potential energy dissipation as work. Note that the word "entropy" originally meant the *dissipation of potential energy*. Asymmetric re-gauging increases the potential energy freely, so it is the exact opposite of the entropy process. I.e., it is a *negative entropy* process.

A tiny (Poynting) fraction of this external EM positive energy flow is diverged into the circuit to potentialize the Drude electrons {67}, and the emf fields drive the current through the circuit, with potentialization energy of the moving

charges being dissipated in the circuit's loads and losses {68}. The huge remainder of the EM positive energy flow—i.e., the *circuital* flow component discovered by Heaviside and unknown to Poynting, since Poynting only considered the part of the flow that is diverged into the circuit to potentialize the electrons—is not diverged because it is in *curled-field* form. *In a flat spacetime* (assumed in the classical theory but seldom specifically pointed out), the divergence of the curl is zero in vector analysis. *It is not necessarily zero when the local spacetime is curved, but classical EM completely omits this case by its assumption of flat spacetime.* However, physics acknowledges that spacetime could be flat only if it were devoid of matter {7}.

Before his death, in unpublished papers Heaviside had also considered gravitational implications of his extra curled-field energy flow component {69}. As Laithwaite pointed out, this may yet have tremendous impact on physics. Quoting Laithwaite {70}:

*“Heaviside had originally written the energy flow as  $\mathbf{S} = (\mathbf{E} \times \mathbf{H}) + \mathbf{G}$ , where  $\mathbf{G}$  is a circuital flux. Poynting had only written  $\mathbf{S} = (\mathbf{E} \times \mathbf{H})$ . Taking  $p$  to be the density of matter and  $e$  the intensity of a gravitational force, Heaviside found that the circuital flux  $\mathbf{G}$  can be expressed as  $p\mathbf{u} - c\mathbf{e}$ , where  $\mathbf{u}$  represents the velocity of  $p$  and  $c$  is a constant.”*

When the extra Heaviside curled-field energy flow component is accounted, every electrical generator and battery is already a COP  $\gg 1.0$  *energy converter*, freely receiving enormous EM energy from the seething local vacuum and outputting it, but *wasting* almost all of it. The generator or battery terminals already output—into space surrounding the external circuit—many orders of magnitude more energy than the operator inputs by cranking the shaft of the generator or by having the battery dissipate internal chemicals. Our own rough estimate of the magnitude of the Heaviside circuital component is that it is often a trillion or more times the magnitude of the Poynting diverged energy flow component that enters the circuit. Note again Evans' calculation {7} of the enormous amount of energy available in the local curved spacetime due to the presence of mass.

In the 1880s and 1890s, no possible source of this enormous *extra* Heaviside energy flow in divergence-free form was known. Special and general relativity and curved spacetime were not yet born, and the very notion of active spacetime and active vacuum was unthinkable. Unable to solve the mystery of the source of Heaviside's extra but huge nondivergent energy flow component, and unwilling to be labeled as a perpetual motion advocate, Lorentz simply originated a clever trick to dispose of the problem itself. He reasoned that the huge curled-field energy flow component “did nothing” because it was not even diverted into the circuit. He believed it “did not interact” and so he stated that it “had no physical significance”.

Consequently, Lorentz integrated the entire energy flow vector around a closed surface assumed surrounding any volume element of interest {71}. This effectively retained Poynting's divergent energy flow component, while arbitrarily discarding the nondiverged huge Heaviside energy flow component, since it subtracted the outgoing Heaviside energy flow component equal to the incoming Heaviside energy flow component.

Lorentz's original argument that such an enormous curled-field energy flow component has no physical significance is still smoothly used by electrodynamicists {72} to "justify" disposing of it, thus retaining the Maxwell-Heaviside assumption of a flat spacetime as a reasonable approximation. No one except Evans {7} seems to have noticed that such enormous EM energy is indeed available in and around ordinary circuits due to their local curvature of spacetime.

#### **1.3.4. Experimental Proof of Heaviside's Extra Energy Flow Component**

This assumption—that there can be “no physical significance” of the Heaviside curled-field energy flow—is rigorously true only for flat spacetime, which does not occur. It is experimentally falsified by the known and widely replicated negative resonance absorption of the medium in the field of optics. A typical experiment yielding COP = 18 is given by Bohren {73}, although scientists in that field carefully speak and write only of the reaction cross section change, and do not point out that the thermodynamic COP > 1.0. That way they are not accused of advocating violation of energy conservation. That is why they use the innocuous phrase “negative resonance absorption of the medium” rather than “excess emission from the absorbing medium”.

When local spacetime is curved, the divergence of the curl is not necessarily zero. In that case, a fraction of the arbitrarily discarded Heaviside energy flow component is diverged after all, turning it into an extra Poynting energy flow component that is diverged and therefore accounted. In such Bohren-type experiments in the IR or UV, the input energy is oscillating. Further, the absorbing charged particles are in tuned particle resonance at that same input frequency. Voila! The very definition of field intensity (as determined by an interacting unit point static charge) is therefore altered. Indeed, the interaction (rigorously, its “reaction cross section”) is dramatically increased, just as surging a rock to and fro in a river's flow diverts more water flow than does the same rock when absolutely stationary. So some 18 times as much Poynting energy flow is re-emitted by the absorbing medium of the resonant particles, as is present in the Poynting component of the input energy calculated for the same particle when static. Yet energy is conserved at all times, since scientists do not account the huge Heaviside energy flow input that actually was made by the operator. Though normally that extra flow does nothing, in the Bohren-type experiment it does do something. Specifically, its divergence becomes slightly nonzero and therefore some 18 times as much real EM energy is diverged into the detector/circuit as is diverged for the nonresonant case.

The other indirect but strong experimental evidence of Heaviside's enormous energy flow component is given by the recent Wilkinson Microwave Anisotropy Probe (WMAP) measurements showing that the universe is comprised of 4% ordinary matter, 23% dark matter, and 73% dark energy {74}. Such a startling percentage of dark (negative) energy is explicable by re-accounting the circuitual Heaviside energy flow component arbitrarily discarded by Lorentz a century ago. The Heaviside negative energy flow component from the Dirac sea holes persisting during sharp gradients is unaccounted and enormous. Huge astronomical explosions can persist for some little period, so that the enormous gradient also persists for some period. Hence the production of rather enormous amounts of negative energy in the unaccounted Heaviside negative energy flow components during these persisting strong gradients. The inescapable conclusion is that the dark energy is negative energy, because it generates antigravity, thereby generating the unexpected but experimentally observed acceleration of the universe's expansion.

### 1.3.5. Problems with the EPE Model and Corresponding Circuits

The Maxwell-Heaviside-Lorentz theory still assumes the material ether, which has been falsified since the 1890s by the Michelson-Morley experiments {75}. The original assumption of the material ether allowed a "hydrodynamic" material fluid theory, since supposedly there was not a single point devoid of mass in the entire universe. In turn, this resulted in erroneously assuming *force fields* in mass-free space, a fundamental error perpetuated in the EPE model to this day.

It is well-known that there exists no force devoid of mass {76,77}, because mass is a *component* of force by the definition  $F \equiv \partial/\partial t(mv)$ . As we previously pointed out, the expansion has two terms, both containing mass. We stated that the standard electrical power engineering theory assumes a flat spacetime (falsified by general relativity for nearly a century) and an inert vacuum (falsified by particle physics since the 1920s and 30s). It therefore specifies only those Maxwellian systems which effectively function—usually because of the use of the ubiquitous closed current loop circuit—as if they had no net active vacuum environment and no net active curved spacetime environment.

The entire electrical power engineering theory (and industry) thus assumes away much of the findings of modern particle physics. The industry's archaic EM model can only be upheld by the ubiquitous usage of the closed current loop circuit, which self-enforces symmetrical self-re-gauging, resulting in the topological subset of Maxwell's theory, previously referred to, corresponding to current EPE usage.

*A windmill analogy can be useful.* So to speak, the conventional electrical power-engineering model is like building a windmill inside a closed barn, so there can never be a free *net environmental wind* to use and do free work, regardless of the atmospheric winds present outside the self-restricting barn. In



that case, the operator himself would have to pay to furnish external energy to rotate the blades and power the shaft and loads.

From the well-known gauge freedom principle, *nature* does not require such an arduous self-limitation. But the electrical engineering model *does* require it, and electrical engineering practice *enforces* it—in every circuit and power system, and in the power grid itself. So to speak, use of the ubiquitous closed current loop circuit shuts the barn door and negates any net usable atmospheric wind by negating any free *net* force field appearing due to asymmetric self-re-gauging. That occurs even though two extra free force fields are still assumed by the re-gauging of the Maxwell-Heaviside equations, as are two changes of the potential energy of the system. But, the two fields are forcibly made equal and opposite so they sum to a net *zero translation* vector summation. Hence, they cannot translate electrons as current, which is necessary to power system loads.

The standard electrical power engineering model erroneously assumes an inert external vacuum and flat spacetime—which is the thermodynamic equivalent of an *inert environment* and therefore an isolated system. The model also assumes that all free re-gauging energy that does arise (because of the re-gauging of the Maxwell equations) is and can only be used to perform *internal* work on the system itself, to produce extra stress in the system. In short, it's like placing two equal rowers in a rowboat, one in front and the other in the rear, and having them row strenuously in opposite directions. Simply simultaneously producing greater but equal magnitudes of forward emf and back emf, does nothing but increase the physical stress of the system. This further requires that all *net* energy utilized to regauge the potential energy of the system *asymmetrically*, so as to allow it to power its loads and losses, must be externally furnished as energy inputs to the system paid for by the operator himself—and not freely furnished from the environment. The model specifically locks up any and all *usable* extra energy inputs received from the active spacetime and active vacuum environment, even though such energy is readily received—and is received in every system. But the system itself has been deliberately designed in such a way that its freely received re-gauging energy from the environment can only do *internal* work on the system to produce excess stress of the system.

The Lorentz symmetrical re-gauging of Maxwell's equations {60} (i.e., to the reduced topological subset, corresponding to lower group symmetry algebra) arbitrarily discarded all those permissible Maxwell systems which freely and *asymmetrically* self-regauge themselves by receiving and using (to power loads) excess potential energy from their active environment and exhibiting a net nonzero free force along with it. *Symmetrical* re-gauging made the equations simpler and much easier to solve analytically, but at the expense of discarding all Maxwellian systems capable of exhibiting  $COP > 1.0$  or  $COP = \infty$  by receiving and using excess EM energy from their vacuum environment. In short, it excluded all *freely* asymmetrically re-gauging Maxwellian systems from using that free energy to power loads.

The ubiquitous closed current loop circuit forcibly makes the “back emf” equal to the forward emf, hence self-enforces Lorentz symmetrical re-gauging. With such a circuit, any Maxwellian system that does freely symmetrically regauge, receives extra energy from its vacuum environment twice, but it must and will use half the received energy in the external circuit to defeat any net use of the other half of the re-gauging energy freely received. In short, it uses its free re-gauging energy to increase the stress in the system, by opposing the forward emf across the external source dipole. It is prohibited from using its free re-gauging energy to forcibly translate electrons as current and do useful free external work in the load.

*Free re-gauging* (freely changing the potential energy of any EM system) does not have to be proven again. It is well established and already an axiom of quantum field theory and gauge field theory. All electrodynamicists use it, including Maxwell-Heaviside electrodynamicists and electrical power engineers {60}.

Any EM circuit or system which fully obeys the symmetrical Maxwell-Heaviside-Lorentz equations cannot output more *usable* energy than it receives from the operator himself (i.e., from its external power source). It cannot just freely receive extra unobservable (virtual photon) energy from the active vacuum and asymmetrically regauge itself thereby. In thermodynamic terms, such a system is a system in self-enforced or self-restored *equilibrium*, hence maximizing its entropy and incapable of exhibiting negative entropy, self-ordering,  $COP > 1.0$ ,  $COP = \infty$ , etc.—all being capabilities permitted to a system far from equilibrium in its energetic exchange with its active environment.

One easily demonstrates that an *asymmetrically* self-re-gauging system can be powered by its active environment, providing  $COP = \infty$  without any energy input by the operator. A circuit containing a load, and powered by a solar cell array is an example. Another is a windmill-powered load performing useful work. Indeed, when the river’s energetic flow is included, a hydroelectric generator system and its entire transmission grid, together with thousands of external loads being powered, is an example of a  $COP = \infty$  electrical power system. Thermodynamically, such a system is far from equilibrium, hence is permitted to exhibit negative entropy relative to the operator’s input energy. In short, the operator need input nothing at all; the active environment inputs it all.

So some known EM systems in a known *observable* active environment—such as a solar cell in the observable sunlight—are able to perform  $COP = \infty$ , since the operator need furnish no energy input at all. In this case, the observable environmental energy input simply replaces the operator’s input that would otherwise be required. The *efficiency* of a typical solar cell may be only 17%, so that it wastes 83% of all the sunlight energy input to it. But since the operator inputs nothing, the  $COP = \infty$  and the solar cell array system with load is said to be “self-powered” by its active *observable* environment (not by the active

*nonobservable* vacuum). We point out that the solar radiation fields and potentials were generated by distant source charges on the sun, and those source charges extracted all that solar energy from the local vacuum there at the sun. So, even the solar cell array is fundamentally powered by EM energy originally extracted from the *distant* vacuum.

All EM energy—in all EM fields, EM potentials, etc.—comes directly from the active vacuum via its interaction with the appropriate associated source charges.

### 1.3.6. Areas Known to Violate the Second Law of Thermodynamics

Kondepudi and Prigogine {42} list several areas already known and recognized to violate the second law of thermodynamics. These areas include (i) rarefied media, where the local equilibrium concept fails, (ii) strong gradients (about which little is known, either theoretically or experimentally—and which are deliberately used in this invention), and (iii) long-lived memory effects in materials.

The present invention uses the fact that strong gradients given by sharp pulses break the equilibrium of the vacuum itself and therefore break its symmetry, lifting some electrons from the Dirac Sea and leaving some temporarily persisting Dirac Sea holes. Because of this broken symmetry, some virtual energy has suddenly become observable energy. The holes in the vacuum do persist during the persistence of the sharp gradient, and often a bit longer. While they exist, the holes serve as negative energy source charges *and thereby produce negative energy EM fields and potentials spreading at the speed of light*. The negative energy EM fields and potentials from these persisting holes are directly used in the process of the invention to produce *convergent* energy flow (a flow of *negative energy*, as previously defined and described). The special characteristics of negative energy are then utilized so that even 300 kilowatt pulses of negative energy can safely be used to transiently charge batteries at an enormous rate, with almost all the energy being freely received in the battery from the external asymmetrical active vacuum environment.

Negative (convergent) energy flow pulses of very large magnitude can be easily obtained and used to charge batteries or capacitors very quickly and impulsively, whereas such large magnitude pulses of *positive* (divergent) EM energy could not be used without probable battery or capacitor damage. Instead of destabilizing the battery's processes as would giant positive energy pulses, giant negative energy pulses *further stabilize them* as if momentarily riveting them to greater stability. Thus by using large magnitude negative energy pulses, the invention is able to impulsively and rapidly recharge and restabilize *stabilized* batteries and capacitors with these large peak intensities of negative energy furnished freely from the momentarily destabilized Dirac Sea.

A capacitor or battery, e.g., does not care whether it is charged by positive energy charges induced onto one plate, or negative energy charges induced onto the other plate, or a combination of both simultaneously.

The advantage of using negative energy is that *enormous energy density pulses can be freely had from the local vacuum environment and used*, charging the capacitor or battery very stably and much more rapidly than is possible using positive energy.

Positive energy flow is always “trying to scatter”, since it is basically diverging energy. Any slightest “obstacle” (impedance) results in more scattering, so that some control is lost and some of the energy so laboriously being held in the flow is scattered away.

On the other hand, negative energy flow is always trying to “further converge and narrow” along its line of travel. Any slightest “obstacle” (impedance) to the control that is prohibiting additional convergence, will thus allow more convergence to occur. The result is an amplification of the actual energy flow being propagated, by excess energy converging into the stream of the flow, from the surrounding asymmetrical vacuum.

In comparison: Positive energy is by nature *diverging*, while negative energy is by nature *converging*. Positive energy is by nature *heating*, while negative energy is by nature *cooling*. Positive energy is by nature *entropic*, while negative energy is by nature *negentropic*. To use positive energy, one must “forcibly” restrain its heating and dissipation tendency, else one “loses” the energy and has less (or even none) left. To use negative energy, one may release the convergence restraints on it, so that one deliberately takes advantage of its natural convergent tendency. By simply releasing the restraints, one thus easily invokes the active environment exchange to furnish even more of the negative energy. One may transduce positive energy to negative energy and vice versa, since theoretically any form of energy can be changed into any other form of energy, so long as the total amount of energy is conserved. A capacitor is such a transducer.

Batteries are stabilized by the process of recharging with negative energy. Over their lifetime of recharging by positive (divergent) energy, at the microlevel the plates develop roughened chemical coatings, spotty chemical corrosions, etc. Recharging rapidly (i.e., with repetitive great power such as 300 KW pulses) with negative energy also rapidly works upon these defect areas, correcting or partially reversing many of them. So the subsequent performance of the battery is enhanced and its lifetime is prolonged. Indeed, *a severely deteriorated battery with appreciable corrosion damage can usually be materially rejuvenated easily and efficiently by using negative energy to repeatedly recharge it* {78}.

By use of negative energy and the *E-amp effect*, this invention analogously forms a *heat-pump-like* recharging situation, in that two energy reservoirs are provided for the energy necessary to do the recharging (or system powering). These are (i) the small positive energy input by the operator, which mostly is used for switching and timing operations that initiate and control the negative energy flow, and (ii) the momentary but very large magnitude negative energy

input which is obtained via the E-amp effect and used for implosive recharging and restabilization of the battery in a very short time.

Corresponding to the use of the compressor to concentrate more heat in a given volume, to enhance its extraction by the heat pump system, in the negative energy system the E-amp effect concentrates (converges) additional energy intensity into the negative energy propagation, thus enhancing its "extraction from the external vacuum environment". This also amplifies the *cooling effect* of the use of negative energy.

This invention transduces excess negative energy from the vacuum (via the E-amp effect) into positive energy, and uses the positive energy to power conventional loads.

#### **1.4. Conclusions**

The radiant energy engineering process allows: (i) very rapid and highly amplified recharging of batteries, capacitors, etc., (ii) direct extraction and use of excess EM energy from the vacuum, (iii) work-free engineering of the mass-free field and potential in space prior to its interaction with mass to produce a force, (iv) producing COP > 1.0 EM systems and electrical power systems, while rigorously obeying conservation of energy, physics, and thermodynamics, (v) producing COP =  $\infty$  EM systems and electrical power systems, while rigorously obeying conservation of energy, physics, and thermodynamics, (vi) a practical process and method for producing and using negative energy, together with evoking and using the environmental amplification (E-amp) effect, (vii) an entirely new methodology for operating and powering EM circuits and electrical power systems, and (viii) a novel new methodology and set of processes which are complex in their theoretical modeling but which are also simply implemented in practical circuits and electrical power systems.

## Section 2: Field, Summary and Objects

### 2.0. Introduction

With the necessary background physics and thermodynamics developed, we now turn to detailing and describing the invention and its operation.

### 2.1. Field of the Invention

This invention relates to the fields of battery charging and electrical powering. Specifically, it provides novel processes, methods, and apparatuses for collecting radiant electromagnetic energy from the active quantum-mechanical vacuum environment (as opposed to voltage and electron current from a conventional source), and using the collected energy for rapidly charging a charge-storage device. The charge-storage device can be at least one battery, at least one capacitor, or some combination thereof. Both negative energy and positive energy may be utilized. The invention invokes and exploits a new environmental amplification effect that can occur in resistive and inductive impedances immediately, and in capacitive impedances after a time delay. The excess radiant energy for powering is received from the active vacuum by free, asymmetrical re-gauging. The radiant energy is received in non-force-field form (non-force-field form being the spatial precursor prior to the precursor's interaction with mass to produce a force field). The received radiant energy can be converted into common force-field electrical energy to supply electrical power for circuits and loads. In a first embodiment, energy input by the operator, as a conventional first energy source, gates radiant energy from the quantum mechanical active vacuum as an unconventional second input energy source, such that more energy for powering is output than the said energy input by the operator, in a manner analogous to a heat pump but utilizing the vacuum as said second energy input source instead of ambient air temperature. A second embodiment harvests the radiant energy for powering only from the vacuum, in a manner analogous to a solar cell but utilizing the vacuum as its sole energy source instead of ambient solar radiation.

### 2.2. Summary of the Invention

In view of the limitations now present in the prior art, the present invention provides a new and useful charger for charging charge-storage devices and a charging process, as well as a new and useful electrical system power source and powering process, capable of rapidly charging the charge-storage devices and also of powering electrical systems and their loads and losses. The invention is simple in construction, conditions and uses the active vacuum as its primary energy source, accepts input energy in a novel and unusual form, transduces the novel input energy and collects it in normal electrical energy form, and then dissipates the collected and transduced electrical energy to power an associated electrical system or device in normal fashion. The present invention uses a natural energy source (the active vacuum with its symmetry broken by strong

gradients) not previously utilized in the field, and is thus more universally usable and more versatile in operation than known prior art. The invention differs from any other known technology in its operation and in its preparation, acceptance, and use of input energy in novel negative energy form. Thus, the invention has many features not offered by the prior art.

The invention relates to a novel way to charge a charge-storage device. In typical embodiments the charge-storage devices can be batteries, capacitors, other similar electrical components, or some combination thereof.

In one aspect, the invention makes use of an inductive oscillator in a one-to-one transformer, or alternatively an inductor, to generate a high potential difference across a destination battery. The potential is collected on the plates of a capacitor then is switched to abruptly discharge the selected capacitor into the destination battery. The sharp discharge gradient results in a burst of extra negative energy from the vacuum, thus charging the battery mostly with negative energy from this latter burst. A major advantage is that the destination battery charges with negative (convergent) energy, thus remains in a cold condition and has very little out-gassing. In a typical application, the total current in the input circuit is no more than 200 milliamps at any time during the operation of the circuit, while negative energy pulses of 300 kilowatt peak power are used for battery charging with great rapidity. The battery so charged with negative energy also transduces the stored energy into positive energy, and subsequently can be discharged to furnish positive energy to do work in conventional fashion.

The invention may utilize any component or means of developing a potential in a capacitor for storage across a battery. The stored potential can then be abruptly discharged across the battery in a potential-switching circuit to initiate the burst of negative energy from the vacuum. For developing the potential across the capacitor, the invention may use solar cells, generators, electrostatic machines, other batteries such as the primary source battery mentioned previously, high energy ignition (HEI) module, etc. For discharging the potential across the capacitor, the invention may use an SCR, MOSFET, IGBT, or other transistor, a contactor relay, or commutator of any kind. A difference potential is developed across the battery so that the semiconductors are in correct polarity when switching the capacitor discharge. NPN or PNP semiconductor devices may be used to perform the switching of the capacitor discharge.

Across the battery there is observed primarily a transient discharge in the form of a voltage spike, as the negative energy burst does not register on most "positive energy" instruments. The greater the number of burst discharges, the greater the amount of negative energy discharged into the battery, and the quicker the battery charges.

The invention utilizes the fact that the common potential  $V$  as used in EM theory is actually the *point energy density of the volumetric potential*, since electrostatic

scalar potential is defined as the potential's point intensity determined by its scattering from (i.e., potentialization of) a unit point static charge. The amount of energy  $W$  delivered to (collected in) the battery depends on the potential's point intensity  $V$  and the amount of receiving charge  $q$  that is present in the battery, by the common equation  $W = Vq$ . It does not depend on the amount of current furnished in the discharge. By using mostly negative energy in the discharge, the amount of positive energy current is dramatically reduced while the amount of negative energy current is dramatically increased. Further, by use of extra negative energy input from the vacuum to the circuit, every section of the circuitry having impedance exhibits negative impedance for the negative energy, and thereby becomes an amplifier of the negative (convergent) energy. This causes additional negative energy to be input into said negative impedances by said active asymmetrical vacuum. The circuitry thus becomes a collection of negative energy amplifiers freely fed at each amplifier by negative energy from the altered local Dirac Sea vacuum, and provides peak power pulses of much greater convergent (rather than divergent) power than the power input by the operator himself. The battery receiving these powerful negative energy pulses is charged by volumetric development and movement of its own internal lattice and fluid positrons, not by insertion of extra electrons furnished from the external power supply. The fact that the primary input charging energy consists of negative energy allows very high peak power pulses to be received and utilized for charging and transformation to positive energy. The result is that the batteries are primarily charged by excess negative energy triggered from the active vacuum, but also convert their acquired excess negative energy into positive energy, for subsequent powering of circuits and devices in normal fashion.

The invention also exploits the fact that any battery-powered circuit actually consists of two independent half-circuits rather than a single closed current loop circuit. The two separate half-circuits are (i) the external loop from the outer surface of one internal battery plate, out through the terminal attached to that plate, and into and through the external circuit to the other battery terminal, thence to the outside surface of the internal battery plate attached to said latter terminal; and (ii) from the surface of one of the battery internal plates, through the internal battery fluid, and to the surface of the other battery internal plate. Internally between the plates, primarily ion current is of interest. Charging with negative energy allows the internal migration of the "ion positrons" composing the positive charges on said positive ions. The invention thus enables the separation and partial separate movement of said internal migrating positron currents, without concomitant amount of electron or negative ion current.

The invention generally comprises a section that periodically discharges a very sharp pulse of electromagnetic energy intensity in a system controlled by a semiconductor that, due to the circuit's use of predominantly negative energy, is connected to the circuitry with polarity reversed, as compared with conventions for semiconductor polarity in typical circuitry employing positive energy. This



results in a sharp pulse of electron-free potential intensity, rather than electron current, thereby sharply increasing the energy density of local spacetime and curving said local spacetime, as well as lifting electrons from the local Dirac Sea, leaving momentarily persistent Dirac Sea holes (negative energy electrons, **not positrons**). As source charges, these sharply-produced negative energy holes in turn produce a sharp pulse of negative energy EM fields and potentials, spreading at light speed in the local vacuum and interacting directly with the ions inside the battery fluid, and on every point inside it. Hence, a little positive energy and appreciable negative energy are received from the vacuum/spacetime directly inside the battery, into the internal battery fluid and its ions, by the reverse-controlled circuit. This sharp pulse of mostly negative energy is directed across a battery or capacitor, reversely to the normal charging polarity, so that the battery or capacitor is impulsively charged with *convergent* negative energy pulses of up to three hundred kilowatts (or even greater) peak power. By using convergent (negative) EM energy, the positive ions  $q$  in the capacitor or battery will and do accept the negative energy  $W$  from voltage  $V$  via the mechanism  $W = Vq$ , faster than from normal positive energy chargers and processes.

The reason for the much higher rate is that the triggered negative energy arises directly from the local curved spacetime everywhere inside the battery fluid, thereby reducing the necessity for all the “negative energy flow” or “negative energy propagation” to move down a wire or through the circuitry. Instead, much of the negative energy used to charge the battery arises from the asymmetric vacuum (curved spacetime) everywhere throughout the battery fluid, interacting with the local positive ions in said fluid, and this input is augmented by the additional negative input flowing in from the circuitry. Further, the negative energy flowing in from the circuitry is first amplified in said circuitry by all impedance elements encountered en route. Hence the battery or capacitor charges up very rapidly from dual energy inputs, with only a small positive energy electron current paid for by the operator but with two powerful negative energy flows, one which arises freely and directly within the battery fluid itself from said internal curved spacetime and the other which flows through the intervening circuitry to the battery and is freely amplified en route. In short, by suddenly converting the vacuum occupied by the battery fluid into an asymmetric vacuum, the broken symmetry of said vacuum injects very high negative energy into all parts of the battery fluid, adding additional rapid charging of said battery.

The charging of the capacitor or battery also converts said negative energy into normal positive EM energy, and this electrical energy can then be discharged in normal fashion to power circuits, systems or devices. Part of the system load can be such a charging system charging batteries via powerful negative energy pulses, while other batteries power the system normally with positive energy. As the powering batteries start declining due to their steady discharging, freshly charged batteries can be switched in to replace them, and the partially dis-

charged batteries in turn can switch to recharging mode and be quickly recharged using the invention's powerful pulses of negative energy.

A short time delay occurs in the battery after the unique potentializing of the positive ions inside the battery fluid. Positive ion currents are much more massive than electron currents, and hence in a capacitive section with negative energy there is a somewhat slowed reaction of the ions as readjustment currents that recharge the battery. However, when the pulse is removed (ends), the inertia of the overpotentialized ions continues their recharging motion for some time thereafter.

Additional advantages exist in that, for the component of negative energy that does propagate through the circuitry, the sharp flow of negative energy passing through an impedance (inductive, resistive, or capacitive impedance) section results in the production of a negative impedance effect—or amplifier effect—wherein excess negative energy freely flows into said impedance section from the activated local environment and curved local spacetime, thus amplifying the output of negative energy into the circuit from said curved spacetime and negative impedance section. For the capacitive impedance section, the environmental amplifying effect occurs after a small time delay. The invention thus converts a normal entropic dissipative circuit (for positive energy) into a freely amplifying negentropic circuit for negative energy—a novel function not previously accomplished in any other battery charging or powering system.

An analogy with a triode vacuum tube will help illustrate the invention's energy amplification principle. The energy furnished by the operator is not the primary energy charging the battery and directed into the invention's system from the altered Dirac Sea, but merely a "gating" and control signal—analogous to how the grid energy of a triode, furnished by the operator, is not the primary energy directed from the cathode to the plate, but only a gating and control signal. In the triode case, the excess energy delivered to the plate over and above the signal energy delivered to the grid, comes from the cathode and its external power supply. Returning to the invention, most of the battery-charging energy comes from the external altered vacuum as an "extra free external power supply," said vacuum having been suddenly made asymmetrical by the sharp gradient of the pulsed potential furnished by the operator. The system is thus converted to a system far from equilibrium with its active asymmetric vacuum environment, freely receiving excess negative energy from said environment. The Dirac Sea in such altered vacuum gradient will have some electrons lifted out, leaving Dirac Sea negative energy holes which serve as source charges producing negative energy EM fields and potentials. In a normal triode vacuum tube, the operator also has to pay for the excess energy delivered to the target plate by the cathode, so the overall COP of the triode is  $COP < 1.0$ . In the invention, the operator does not have to pay for the vacuum negative energy delivered to the target battery fluid, so the COP is  $COP > 1.0$ . In practice,  $COP = 20$  to  $100$  is readily achieved for a system without positive feedback to

provide the operator's furnished energy, and higher COPs are possible with that arrangement with additional tuning and refinements. When positive feedback of some of the system's output positive energy is also used to provide the operator's furnished positive energy input,  $COP = \infty$  is permitted by the laws of physics and thermodynamics of an open system far from equilibrium. Further, this feedback and  $COP = \infty$  are readily achievable by implementing the required governed positive feedback of positive energy.

Via the E-amp effect, a multiple stage 1:1 pulse transformer actually serves as a powerful negative energy amplifier, with the input energy to the amplifier coming from the active vacuum environment. Multiple stages of such transformers can serve as multistage E-amps. The invention's charged capacitor and the charging battery also increasingly exhibit the E-amp effect after some period of operation.

The foregoing has outlined, in general, the physical aspects of the invention and is meant to serve as an aid to better understanding the operation of the system. Significantly, this invention can be embodied in numerous other specific forms in addition to the ones portrayed, without departing from the spirit or essential attributes thereof. Accordingly, reference should be had to the following objects and claims as indicating the scope of the invention but not limiting the embodiments and applications.

### **2.3. Objects of the Invention**

A principal object of the present invention is to condition the local vacuum and curvature of spacetime by re-gauging the local vacuum potential and breaking its symmetry, so as to provide an external source of extra potential EM energy input to the system or process, in addition to the energy input by the operator or external power source. The availability of an extra free environmental source of input energy overcomes the deficiencies of those prior art devices which require that the operator input and pay for all energy that is input and used to power the system or process, its loads, and its losses.

An additional object of the present invention is to take advantage of the usually divergence-free Heaviside circuital component of energy flow in the space outside the conductors in a circuit, said circuital form of energy flow being in curled field form. While the divergence of the curl is zero in flat spacetime, in sharp gradients—such as strong pulses with sharp rise time and decay time—the local spacetime is curved, although that is not modeled by conventional electrical power engineering and electrodynamics. In a curved spacetime, the vectorial divergence of the curl need not be zero, and so excess EM energy is freely made available during the persistence of the strong gradient. Hence excess energy does exist in the local curved spacetime, in the form of the Heaviside curl field energy converted into a mix of mostly curl field energy and some divergence field energy, and where said divergence field energy component is

received and utilized in the circuit as an excess energy input freely received from the asymmetrical environment.

Moreover, an object of the present invention is to provide an external, conditioned, second energy reservoir, being said conditioned and asymmetrical local vacuum and spacetime, such that the excess energy input to the system or process from said second energy reservoir is also by means of asymmetrical re-gauging (work-free change of potential), which results in this excess energy being *freely* received by said system or process in compliance with the gauge freedom principle. The result is a practical mechanism and process that asymmetrically and freely changes (re-gauges) the potential energy collected in the system, and then uses this collected extra re-gauging potential energy as part or all of the energy dissipated by the system or process to power said system or process, its loads, and its losses.

Another object of the present invention is to provide said external extra energy reservoir, such that by sharply pulsing said altered environment a strong gradient is established between said extra energy reservoir and the system or process. As recognized in nonequilibrium thermodynamics, said strong gradient places the system far from equilibrium in its energy exchange with said active asymmetric environment, and thus violates the equilibrium assumed by the second law of thermodynamics, thereby establishing a free flow of ordered energy from said external energy reservoir to the system or process for its collection, transduction, and further usage. However, as also recognized, the *mechanism* by which the strong gradient violates the second law of thermodynamics has not been previously understood either experimentally or theoretically, as pointed out by Kondepudi and Prigogine in their definitive book, Modern Thermodynamics, 1999, p. 459. The present invention uses part of the unknown aspects.

Another object of the present invention is to freely provide said external extra energy reservoir, and said strong gradient, so that Dirac Sea electrons are lifted from the local vacuum, leaving momentarily persisting unfilled Dirac Sea holes as negative energy electrons, further acting as source charges.

Another object of the present invention is to provide said Dirac Sea holes as momentarily persisting source charges, whereby said source charges pour out negative energy EM fields and potentials via the asymmetry of the charges and the polarized vacuum with opposite virtual charges, and wherein said negative energy EM fields and potentials and their negative energy are input to said system and process and interact with it, and where said negative energy cools the processes instead of heating them.

Another object of the present invention is to provide said input energy from said free source of EM negative energy in a sharply pulsed form, wherein said input pulsed negative energy is *convergent* rather than *divergent*, and wherein far more such convergent energy can be conducted without damage along the conductors per size than is possible with positive energy, and wherein the

greater magnitude of convergent pulsed negative energy can be used to help charge a battery or capacitor up to 50 or more times faster than can be accomplished by using divergent positive energy.

Another object of the present invention is that, through using negative energy rather than positive energy to charge the batteries or power the E-amp circuit, the batteries or the E-amp circuit are not heated or damaged, but are cooled, even though very high peak power pulses of 300 KW or more can be utilized for implosive charging.

Another object of the present invention is to provide said negative energy impulsive charging, which also can serve to partially rejuvenate and reverse many kinds of deterioration and cumulative internal damage of said battery or capacitor, by partially reversing previous damage or deterioration due to positive energy charging, thus improving and extending the life cycle of the component thus charged.

Another object of the present invention is to provide said negative energy impulsive charging, with partial rejuvenation of previous battery or capacitor damage or deterioration from positive energy charging, such that the mean time between failure for said battery or capacitor can be extended, and wherein said system mean time between failure is extended accordingly.

Another object of the present invention is to utilize said flow of negative energy through resistive and inductive conducting paths to a capacitive collector or battery, such that said resistive and inductive elements immediately act as environmentally-driven negative resistors and as *cooling* environmental amplifiers (E-amps) for said negative energy input flow along said path, further adding excess negative energy from the environment to the negative energy flow received by the collecting battery or capacitor.

Another object of the present invention is to utilize said flow of negative energy through capacitive sections such as capacitors and the battery itself, such that said capacitive elements also act as environmentally-driven negative resistors after a time delayed operational period, and thus serve as additional environmental amplifiers (E-amps) for said negative energy input flow along said path, further adding excess negative energy from the environment to the negative energy flow received by the collecting battery or capacitor.

Another object of the present invention is to utilize the battery charging or capacitor charging in what for positive energy would be a reversed polarity.

Another object of the present invention is to widely application in cooling of circuitry, as well as for general refrigeration. The future incorporation of negative energy circuits into the fabrication of microchips, both for self-powering and self-cooling, is expected to provide significant reduction in size and costs of great assemblies of microcircuits, presently limited by heating effects and necessity for separate cooling.

Another object of the present invention is to utilize said capacitor or battery charging in reversed polarity, so that said battery or capacitor when charging acts as a transducer of the received impulsive negative energy, transducing the rapidly received negative energy into stored positive energy added to said battery or capacitor, without incurring the heating and damage that would result from use of positive energy charging pulses of such high peak power. The overall result is that said battery or capacitor receives negative energy impulsively and strongly at up to a few hundred kilowatts in peak power or peak energy flow rate (peak charging rate), while simultaneously transducing the rapidly received excess negative energy into excess stored positive EM energy. In this manner, the battery or capacitor is very rapidly charged with excess transduced positive energy, up to 50 or more times faster than can be done with direct input of positive energy rather than input of negative energy, use of free environmental amplification of the input negative energy by impedance sections, and conversion to stored positive energy as the battery is charged by negative energy.

Another object of the present invention is to accomplish negative energy input and charging where said resulting transduced stored positive energy is substantially greater in magnitude than the positive energy input provided by the operator to evoke and utilize said process and mechanism. The excess energy is freely received in the excess negative energy input from the environment and through the environmental amplification effect, so that overall conservation of energy is obeyed at all times.

Another object of the present invention is to provide said pulsed negative energy rapid charging method and system wherein the charged battery or capacitor transduces the impulsively input negative energy into conventional positive EM energy, thus increasing the stored energy in said system or process as normal positive energy, although it was impulsively received from said external extra environmental energy source as negative energy amplified by resistive and inductive elements en route to the battery or capacitor collector.

Another object of the present invention is to provide a system or process whereby negative energy is freely received from an externally conditioned environment, and where a combination of batteries or capacitors is used, and where one part of said combination is used in the role of a receiver/collector/transducer for the incoming negative energy while simultaneously a second combination of batteries or capacitors is used in a positive energy discharging and powering role for powering said system or process with normal positive energy, and wherein periodically the aforementioned roles of the devices are swapped so that freshly charged batteries or capacitors are placed into the role of positive energy powering units, and simultaneously the somewhat-depleted batteries or capacitors formerly used in a powering role are placed into the receiver/collector/transducer charge-receiving role to be rapidly pulse-charged via the environmentally amplified impulsive negative energy mechanism and

process of the invention. The result is a continuously powered system freely taking most or all of its required input energy from the external active vacuum energy reservoir.

Another object of the present invention is to provide a system or process wherein the system or circuit is converted into a non-equilibrium system, freely receiving and utilizing excess energy from its active environment in a manner analogous to a common home heat pump with two energy reservoirs, one furnished by the operator and the other furnished freely from the environment. Analogous to how a heat pump expends a little energy to compress the air and thus extract a greater amount of energy than was expended to compress the air, the invention processes and asymmetrically conditions the external vacuum and curved spacetime environment in order to extract more energy than the positive energy required to condition and process said environment.

Another object of the present invention is to provide said system or process wherein the power input by the operator is also further made a part of the system or process load, so that the system or process becomes "self-powering" in that no further energy input by the operator is required, and all energy input used in said system or process is furnished from the external conditioned environment via free asymmetrical re-gauging of the system's potential energy, analogous to the operation of a conventional system powered by a solar cell array in a solar radiation environment, except that the active environment is now the conditioned local vacuum and curved spacetime.

Another object of the present invention is to provide a means of conditioning and affecting the fields and potentials of its external environment while they have not interacted with charged mass and thus are still in *force-free* and *mass-free* form. By this means, the invention is able to interact and condition its active environment via free re-gauging, without the requirement to do work, since there is no force involved in said reconditioning and hence no translation of force through a distance (which would require work). This invention deliberately exploits the present error in classical electrodynamics that assumes a force field in space by assuming that space contains the mass of a luminiferous material ether (the ubiquitously assumed unit point charge at each spatial point), more than a century after the Michelson-Morley experiments destroyed said material ether. The textbook definition of said EM fields (their intensities) still retains a unit point charge and its mass in the interaction; hence still retains the material ether, although leading physicists such as Nobelist Feynman have pointed out the error. The invention also exploits the fact that normal classical electrodynamics and electrical engineering do not calculate and use the field and potential themselves as such, but only calculate the static-charge-intercepted *point intensity* of said field and the *point intensity* of said potential, and that the standard model erroneously assumes that a unit point static charge containing mass has been placed at every point in space, and also assumes the massless field in mass-free space is in ongoing interaction with the mass of said static

charge. The present invention interacts with *mass-free* fields and potentials (the *precursors* of the material fields and potentials used in conventional electrical engineering and devices, and which precursors subsequently interact with mass to form the actual EM force fields) in the absence of any point unit charge, so that *re-gauging* is the reaction utilized, not force field reaction with charged mass. This is a totally new electromagnetic function utilized in the invention, and this function does not appear to have previously been deliberately used in any prior art. The invention primarily interacts with and changes the mass-free *precursor* of the force field, not the force field itself. Changing a force field requires thermodynamic work since it is a material external parameter of the system, while changing the *precursor* to the force field does not require thermodynamic work since the precursor is not a material external parameter of the system itself, but merely a characteristic of the local spacetime and the local vacuum. Thus the invention interacts directly and work-free to change the virtual particle flux of the local active vacuum and the local curvature of spacetime, freely changing them by re-gauging under the gauge freedom principle. This directly alters the vacuum flux and spacetime curvature *precursor* of force field and potential, and said *altered precursor* then interacts with the charged mass in the system or process so that *altered force fields and altered potentials* in the charged mass of the system are freely obtained, compared to what would have been present without the interaction and change of said altered precursor. This is a direct application of the principle that there does not exist in nature any “conservation of work” law, but only a “conservation of energy” law, and force interaction is not necessary to merely change potential energy or field energy, since such can be changed freely by re-gauging. With *re-gauging*, energy is conserved at all times but local work done on and by the system need not be conserved, since the potential energy increases of the system or process are accomplished by re-gauging and are permissibly and freely made under the gauge freedom axiom in work-free manner.

Another object of the present invention is to thus to provide a system or process wherein radiant energy—“radiant energy” here referring to potential and field energy in force-free and thus mass-free form, and thus in the *precursor* form prior to formation of force fields and normal potentials already interacting with charged mass—is used in the primary *precursor* functions of said system or process, rather than with force field energy and potentials that are already interacting with charged mass. This is a totally new electrodynamic system and process function not utilized in the prior art.

Another object of the present invention is to provide a system capable of charging a charge-storage device, or an electrical powering system or process, that is partially or totally powered by energy freely received from its external vacuum environment, and thus is more universally functional in today’s market, and in diverse locations and environments, than the prior art devices wherein the operator must provide and pay for all the input energy.



Another object of the present invention is to provide a system capable of charging a charge-storage device, or an electrical powering system or process, that is partially or totally powered by energy freely received from its external vacuum environment, thus reducing or eliminating the need for—and costs of—external fuel, pipe lines, external power sources, transmission lines from a centralized power distribution grid, and storage and transportation costs for fuel and fuel support and processing facilities.

Another object of the present invention is to provide said novel system or process, or primary power source, whereby only standard electronic parts and supplies are utilized and required, and whereby only normal construction and manufacturing capabilities, procedures, and work forces are required, so that initial acquisition costs for the new chargers and power systems are highly competitive. Further, the great reduction in support costs such as fuel, transport, and storage costs, together with extended battery and system life and increase of mean time between failures, make the new systems much cheaper to operate than prior art devices.

Another object of the present invention is to provide a battery charging and capacitor charging system and process, and an electrical power system, wherein a 1:1 transformer operates as an environmental amplifier for negative energy, and freely increases the input negative energy by free re-gauging from the external active environment.

Another object of the present invention is to utilize a standard circuit, containing normal electronic components, in a novel manner, whereby negative energy rather than positive energy comprises the main energy flow in the circuit and interacts with it from the external environment, and whereby all sections of said circuitry having impedance (being resistance, capacitance, or inductance or any combination thereof, and comprised of any types of electronic components whatsoever) also act as free amplifiers such that excess negative energy is freely input to the negative energy flow in the circuit, from the external environment via the impedance sections.

Another object of the present invention is to provide a battery charging and capacitor charging system and process, and an electrical power system, wherein the input of excess environmental energy is in the form of powerful negative energy pulses.

Another object of the present invention is to provide said charging system and process, and power supply, wherein a full wave rectifier is used to produce all-positive-going or all-negative-going energy input pulses from said active environment.

Another object of the present invention is to provide a system or process whereby the useful output is usually greater at nighttime, or during periods of geophysical upset of the environment, than in daytime, but wherein conventional

means are included to regulate the varying output to the output that is required or needed.

Another object of the present invention is to provide said charging system and process, and power supply, wherein an SCR or other solid-state semiconductor device is utilized in reverse to switch the negative energy pulses.

Another object of the present invention is to provide said charging system and process, and power supply, wherein a TRIAC or other device similar in bidirectional functioning is utilized to take advantage of negative energy flowing in an opposite direction from that of positive energy, under the same circuit potential or field conditions.

Another object of the present invention is to provide said charging system and process, and power supply, wherein a neon tube or other discharge device is utilized to switch the negative energy pulses.

Another object of the present invention is to provide said charging system and process, and power supply, primarily using negative energy freely received from the asymmetric vacuum environment, wherein the full variety of normal electrical loads can be powered, such as motors, generators, electronic circuits, and other systems and processes.

Another object of the present invention is to provide said charging system and process, and power supply, primarily using negative energy freely received from the asymmetric vacuum environment, wherein the standard closed current loop system is altered to become an open dissipative thermodynamic system freely receiving excess energy (in negative energy form) from its active environment (the active local vacuum and local curved spacetime).

Another object of the present invention is to provide said charging system and process, and power supply, wherein the system or process does not output or introduce radioactive or chemical wastes, harmful exhausts, carbon dioxide, unwanted radiation, or chemical pollution byproducts into the environment.

Another object of the present invention is to provide said charging system and process, and power supply, wherein the cooling negative entropy effect of negative energy offsets or counterbalances the heating effect of the entropy powering components and loads, thus substantially reducing or eliminating *net* heat production released into the environment, which together with no emission of carbon dioxide substantially reduces the contributions to global warming of electrically powered processes and systems using the invention. The use of a negentropic process to furnish extra energy automatically provides a net reduction of waste heat released into the environment.

Another object of the present invention is to provide power and propulsion systems for electrically powered vehicles, trucks, ships, trains, aircraft, ships, and other transport systems that do not consume hydrocarbon fuel or utilize nuclear propulsion systems, and do not produce harmful byproducts, emissions,

and pollutants into the environment, while also reducing or eliminating the net heat released into the environment.

Another object of the present invention is to provide said charging system and process, and power supply, wherein the SCR or solid-state semiconductor is replaced by a neon tube, plasma tube, transistor, or other discharge device to discharge the pulses of negative energy in radiant energy form. Many other variations are possible, so long as the primary principles of the extraction, amplification, and conversion of negative energy in radiant energy form are implemented.

Another object of the present invention is to provide said charging system and process, and power supply, wherein any external source of voltage such as an elevated antenna wire can provide the potential required to charge the battery or capacitor with environmental negative energy obtained freely via re-gauging, and thus power the process or system and its loads and losses.

Another object of the present invention is to provide said charging system and process, and power supply, wherein a suitable timer and switching, such as a 555 timer together with an optical coupling switching device, are utilized to time the switching of the negative energy pulses of radiant energy.

Another object of the present invention is to provide said charging system and process, and power supply, wherein a series resonant high voltage switching circuit is utilized to time and switch the negative energy pulses of radiant energy.

Another object of the present invention is to provide said charging system and process, and power supply, and said switching and timing subsystems, and said collector/transducer systems, whereby the freely received negative energy pulses from the active environment are received at peak power levels of a few hundred kilowatts of power input without damage to the devices being charged.

Another object of the present invention is to provide said charging system and process, and powering system, in a form easily scaled down for small packages powering miniature and small systems such as watches, clocks, and lap top computers, and electrical appliances, or easily scaled up for large packages powering large and very large systems such as electric automobiles, electric trains and trucks, electric airplanes, and electric ships and submarines, and large power systems regulating building-sized capacitors used in main power grid demand-filling applications.

It is intended that any other advantages and objects of the present invention that become apparent or obvious from the detailed description or illustrations contained herein are within the scope of the present invention.

## Section 3: Functioning of the Invention

### 3.0. Introduction

This section presents the remainder of the drawings and their description, as well as the detailed operation of the invention.

### 3.1. Brief Description of the Drawings Including Recapitulation

The following drawings include a recapitulation of Figure 17 through Figure 25 used to this point, and further describe by illustration in Figure 26 through Figure 36 the operation, advantages, and objects of the present invention. The full schematic of the typical system is shown in Figure 17, but the individual parts are first shown in Figures 10-15. A detailed description of the invention's operation is given in the subsequent paragraphs after these brief descriptions of the component drawings.

**Figure 17** shows the three components of the supersystem. These three components interact continually with each other.

**Figure 18** shows that the standard classical EM model and electrical engineering include the physical system, but exclude the other two components of the supersystem, being the active vacuum and curved spacetime.

**Figure 19** shows the operation of a prior art electrical power system, where the operator inputs and pays for all the energy input. Performance of such prior art systems is limited to  $COP < 1.0$ .

**Figure 20** shows the operation of a prior art solar-powered electrical power system, enabling  $COP = \infty$  performance.

**Figure 21** shows the two-reservoir energy input system used in the prior art common home heat pump, and enabling  $COP > 1.0$  performance.

**Figure 22** shows the arrangement and schema for the operation of the invention in  $1.0 < COP < \infty$  operational performance mode.

**Figure 23** shows the arrangement and schema for the operation of the invention in  $COP = \infty$  operational performance mode.

**Figure 24** shows the mechanism for amplification of negative energy flow in impedance sections of the invention, when sharp gradients (pulses) are used.

**Figure 25** shows typical circuit elements that have impedance and exhibit environmental amplification of their negative energy flow, when sharp gradients (pulses) are used.

**Figure 26** shows a schematic of a first part of the system, being an inductance-coupled impedance-matching oscillator trigger device. A tri-filar inductive-coupled transformer section also acts as a negative impedance and an environ-

mental amplifier for negative energy, even though for positive energy it is a 1:1 type winding. The negative impedance freely receives excess negative energy from the active environment, so as to produce and amplify the input negative energy from the sharp gradients into greater negative energy pulses in the output. A full wave rectifier keeps the amplified output pulses all positive above a reference zero axis. In this example, a 12-volt battery is used to power the trigger device. While a 12V battery is shown in some of the drawings, it is merely one preferred embodiment, or an example; as will be apparent to one skilled in the art after reading the descriptions. Other batteries could be substituted and other voltages used without departing from the spirit and scope of the invention.

**Figure 27** is an oscilloscope picture of the rectified above zero reference negative energy pulses that are output by the oscillator-trigger unit in Figure 10, showing a rapid buildup and discharge of successive pulses, being part of the environmental operation providing amplification of input negative energy from the environment.

**Figure 28** is a schematic of a second part of the system, in one embodiment being a free-running 555 timing circuit that drives a high voltage opto-coupler for discharge of the high potential charge in a capacitor across a series resonant circuit to at least one battery. In an alternative embodiment a neon bulb can replace the timing circuit.

**Figure 29** is a schematic of the invention's high voltage switching, environmentally amplifying, and battery charging operation. The SCR shown is mounted in inverted position, because of the use of negative energy. The battery part of the circuit, receiving the negative recharging pulses, is in floating ground condition and is isolated from the main grounding of the system.

**Figure 30** is an oscilloscope trace of the high voltage switching potential across the battery under charge in its floating ground situation. Polarity inversion is used in applying the signal, because of the use of negative energy charging.

**Figure 31** is a schematic representation of the scheme or process for battery charging from an environmental source of high voltage. A capacitor is charged to high potential, and then this potential is used to furnish a sharp negative energy gradient across a receiving battery, from a switching, amplifying, and discharge circuit establishing the sharp gradients with the external environment so as to provide negative energy pulses of substantial negative energy and power.

**Figure 32** is a schematic for one embodiment for providing the necessary high potential from the external environment, with the high voltage potential being furnished by an elevated antenna of 200 feet in length, 30 feet above the earth. This antenna taps into and intercepts the earth-to-electrosphere potential, which is a nominal 200 to 300 volts per meter. The connection to the high voltage capacitor (which may be of small capacitance) charges the capacitor to that

potential between the antenna and the earth. The resulting pulses from the system establish the sharp gradients with the local vacuum potential and curved spacetime, thus providing an environmental amplifier for negative energy and a negative energy flow from said altered local environment into the system and across the battery, charging it with powerful pulses of negative energy. Note that the battery is isolated from the earth grounding of the system, and is on a "floating ground."

**Figure 33** is a schematic for a full radiant battery charger and power supply embodiment using an SCR in its switching circuitry. In this embodiment, the battery on the left side of the schematic is used as the power-furnishing battery, and it discharges electrical energy in normal positive energy mode to power the circuitry. In the output there are two additional 12 volt batteries as the load, and these batteries are being very rapidly charged by excess, amplified negative energy furnished from the altered local vacuum environment and local curvature of spacetime.

**Figure 34** is a schematic for powering a monopole electrical motor by the full circuit shown in Figure 17. For continuous operation, the roles of the powering battery leftmost in the diagram and of a recharging battery to the right in the diagram can periodically alternate. In this manner, battery roles alternate between recharging and powering mode, so that a freshly charged battery is always powering the system, while two batteries are recharging quickly using highly amplified pulses of negative energy freely received from the external environment. In this way, the unit is a continuous power unit for the motor as the desired output load, which in turn powers a shaft load—which may be any normal shaft load used with electrical motors. This is a schematic for a self-powering system, freely powering itself and its losses and load with re-gauging energy freely received from its active external environment.

**Figure 35** shows an application system using Earth Cells with a potential switch and a transistor.

**Figure 36** shows an aspect of the invention in such a manner that the circuit's operation as an inverted potential switch can be better understood, considering also the use of negative energy rather than positive energy. The inverted potential switch can be further modified to optimize the receipt of negative energy through the E-amp effect. However, that will be the subject of a separate Provisional Patent Application.

### **3.2. Detailed Description of the Invention**

Because the invention is of unusual novelty and makes the first deliberate use of negative energy freely received from the asymmetric Dirac Sea vacuum in charging batteries and powering electromagnetic systems, and also makes the first deliberate use of free environmental amplification of negative energy flow in resistive, inductive, and capacitive circuitry sections of the invention, a considerable summary of the necessary science was provided in Section 1 to

enable persons skilled in physics and in the standard electromagnetic art to understand the invention's operation, objects, and performance.

The following description assumes familiarity with the material and references previously cited in Section 1 on p. 51.

### **3.2.1. Summary**

The invention consists of a method, system, and apparatus to (i) alter the local ambient active vacuum environment that surrounds a charging system, making said active vacuum asymmetrical, (ii) freely extract energy from that altered vacuum environment, and in particular to extract EM negative energy, (iii) provide free re-gauging amplification of said EM negative energy by additional receipt of additional excess energy from the altered active vacuum—a process called environmental amplification (E-amp)—in circuitry sections having impedance and through which the negative energy flows, (iv) transform the extracted negative energy utilized to charge batteries into useful positive electrical energy which may be further utilized to recharge additional batteries and/or power circuits, loads, and devices, and (v) implisively charge batteries with high-powered (up to 300 KW in the examples given, or even higher) pulses of negative energy. It should be understood that scaled-down or scaled up embodiments could use different peak pulse power than the 300 KW typical of certain preferred embodiments hereof. For very small applications, the peak power pulse used is much smaller, and for very large applications it can be much larger.

In the examples given, the various operational parameters listed—such as 12V and 300 KW and the particular components such as SCR, 555 timer, opto coupler, 1:1 transformer, 1 KV diode bridge, etc.—are simply with respect to a preferred embodiment, and other equivalent components and operational parameters can be substituted without departing from the novel spirit and scope of the invention.

The particular schematics, components, and operations shown will allow an understanding of the operations themselves, and will demonstrate the principles and concepts for deliberately extracting and using radiant energy from an altered asymmetrical vacuum, the novelties of processing, amplifying, and using said radiant energy while still in force-free field form, and demonstrate circuits made from normal electrical components for transducing collected negative energy into EM positive energy so it can easily be used in conventional fashion by conventional circuitry to power conventional loads and devices.

The operational parameters are thus presented to illustrate a preferred embodiment or embodiments, for the purpose of teaching the invention, and not by way of limitation.

### 3.2.2. Inductive Coupled Oscillator and Diode Bridge

The Invention makes use of an *inductive coupled oscillator*; which is built around a one-to-one tri-filar-wound (3-wire wound) transformer. The transformer is a one-to-one impedance matching device where all the windings have the same turns ratio. The transformer is wound on an open iron core with no closed flux paths. This impedance matching device serves as is a trigger and amplifier for radiant energy collection.

**Figure 26** on p. 42 shows the inductive-coupled oscillator and parts comprising the trigger device. The oscillator produces a stream of high-potential spikes that are comprised of radiant energy consisting of high potential with high rate of change  $d\phi/dt$ , with no normal current  $dq/dt$  but with high negative energy current of Dirac holes and negative energy flow. Thus  $d\phi/dt \gg 0$ , while  $i = dq/dt = 0$ . This oscillator uses inductive coupling and a very small resistance and capacitance in the wires that make up the transformer/amplifier itself. Because of the sharp gradient  $d\phi/dt$ , electrons are lifted from the local Dirac sea, leaving momentarily-persisting negative energy Dirac 4-holes. Consequently, the oscillator involves a strong component of negative energy, and the impedances of the conductors and circuitry act as environment amplifiers for said negative energy. The oscillator will resonate at the natural frequency of the material used. The oscillator also self-regauges itself in a buck boost operation, changing its own output energy density. A Litz-type wire would be advantageous to obtain maximum radiant energy transfer (maximum charge coupling and thus maximum current) through the transformer. The diode bridge consists of high voltage diodes in the 1 KV range. The capacitor is chosen with a voltage rating suitable for the potential to be used. This oscillator has a very short duty cycle, where its on time is very short compared to its off time (as will be described with respect to Figure 27). This is to optimize the sharp gradient characteristic and thus optimize the usage of negative energy as well as the environmental amplification (E-amp) effect of the innate resistances and impedances of the conductors.

It may be seen from the circuit in Figure 26 that the inductive oscillator is fed to a high voltage diode pack to capture the high voltage spikes for storage in a capacitor bank. After the capacitor stores the energy, a separate circuit selects the time interval for discharge. This latter circuit is isolated through an opto-coupler because of the high voltage potential.

When the timing circuit switches voltage to the opto-coupler, the circuit then discharges the capacitor into a battery bank. When the capacitor level equals the battery voltage the switching circuit then turns itself off until the next discharge. When using an SCR, the capacitance is chosen to be small in microfarads,  $1\mu\text{f}$  to  $10\mu\text{f}$ . The SCR turns itself off because of the reverse polarity when the capacitor has discharged to the battery voltage level. All the circuits that control the opto-coupler are in parallel with the same primary input battery, as shown in the



circuit configuration. Many circuit configurations are possible to those skilled in the art.

The circuits for a preferred embodiment of the present invention use a similar 1:1 transformer as Bedini's U.S. Patent 6,545,444 B2, but here the component performs a negative-energy function in the circuit. The coil is made into an inductive oscillator using the transistor arrangement with added resistors. The diode bridge is similar, but the capacitor is changed in value and voltage. A 555-timer circuit is added to drive the opto-coupler at a low frequency level rate to discharge the potential switching device.

In Figure 27 on p. 42 it can be seen that the oscillator waveform sharply builds potential charge in waves and that the on time is very short compared to the off time. The probe used was a times 10 so the peak voltage in Figure 27 corresponds to a scale of about 160 volts before high voltage rectifiers receive the signal. Once received by the high voltage rectifiers, the potential on the collector-condenser, in this aspect, is about 226 volts. The collector-condenser may be a standard capacitor, where "condenser" refers to "capacitor" and "collector" refers to the capacitor's function in the circuit to accumulate energy then discharge it later. Here the capacitor is being charged by negative energy, in the manner previously described.

Following local vacuum changes, radiant waves are always changing the nominal magnitude of their potential spikes while the oscillator is operating. As could be expected, the activity of the local "night vacuum" differs from that of the local "day vacuum", since during daytime there is appreciable ongoing activity of light and thermal radiation from the sun, interacting with the local vacuum, and appreciable time-delayed effects from capacitive E-amplification occurs. At night, much of this "interfering solar EM activity"—that decreases Dirac hole production—is reduced. Consequently, it has been noted that the radiant energy waves are appreciably stronger at night than during the day. At night, voltages from the inductive coupled oscillator-trigger device have been measured up to about 300 volts on the collector condenser.

### **3.2.3. The 555 Timer Circuit**

Referring now to Figure 28 on p. 43, the second part of this circuit consists of a free running timing circuit for operation of the discharge of the energy received in the collecting condenser. Shown is a 555-timer set that resets itself for continuous operation at a set operating frequency, in a low frequency range.

A neon lamp can also be used to replace this circuit, and in other embodiments of the invention such replacement has been successfully employed.

The main purpose of the Figure 28 timing circuit is to drive a high voltage opto-coupler for discharge of the high potential charge in the condenser across a series resonant circuit to the battery, or batteries.

The timing circuit operates as follows: The 555 timer is set to a low frequency pulse. This circuit is hooked in parallel with the inductive-coupled radiant energy generator so that they both start up together.

Thus, when the unit is switched on, the radiant generator is a free running inductive coupled oscillator at about 25 KHz. For negative energy, it is also an E-amp. The timing circuit is a slow-running oscillator fixed at about 50 cycles per second, with a square wave output.

The timer circuit output, when going high, triggers the opto-coupler into operation. The 555 timing circuit is out of phase with the radiant oscillator circuit and remains that way under operation. The timing circuit only uses its current to cause the diode in the opto-coupler to turn on when the 555 goes high or is pulled up to vcc.

The total current dissipated in the two circuits together is about 120ma, depending on which transistor is being used in the oscillator circuit.

#### **3.2.4. Series Resonant High Voltage Switching Circuit**

Referring now to Figure 29 on p. 43, we show the final part of the circuit for the preferred embodiment of the invention, which is a series resonant high voltage switch, herein called the *switching circuit*.

The Figure 29 switching circuit uses a special arrangement of (i) the opto-coupler high voltage output transistor, and (ii) a second high voltage-switching transistor to make up a high gain switching Darlington arrangement to drive the gate of the high voltage SCR.

This circuit does not draw any current  $dq/dt$  from the primary battery when switching, since the arrangement provides a voltage (potential difference) switch. The potential difference switch is *inverted*, in order to use the negative energy and the E-amp effect, as can be seen from the diagram.

Thus, when the high voltage builds across the capacitor and the battery, the normal negative pole of the battery becomes positive in potential. The Darlington arrangement will bias itself on when the switching signal from the opto unit is triggered. The SCR will turn itself off when the voltage across the capacitor equals the battery voltage. When the SCR turns off, at this point the battery assumes its normal condition of positive and negative poles but with a significantly enhanced energy charge having been delivered, due to the negative energy utilized together with the E-amp effect.

Excess energy—particularly in negative energy form—has freely been added from the active vacuum environment by the E-amp effect and by the use of negative energy and SCR inversion. The switching circuit is then out of phase with the primary circuits.

The overall effect has been to move the circuit's primary operation into that of free asymmetrical re-gauging, where excess energy (mostly negative energy) is

freely transferred from the external altered vacuum environment to the battery via the sharp pulse discharges, enabling free environmental amplification (E-amp).

For the charging cycle, the system is thus in an open thermodynamic system configuration, far from equilibrium and freely receiving excess negative energy from its local asymmetrical vacuum environment.

In thermodynamics, such a system can output more energy than the operator inputs, since the excess input energy is freely received from the active environment. Thus  $COP > 1.0$  operation and  $COP \gg 1.0$  operation are allowed.

Referring now to Figure 30 on p. 44, which is an oscilloscope trace from a times-0 probe at 10 volts per division, it can be seen that the switching across the battery is just a high voltage potential placed across it. It should also be noted that the grounds of the parts of the system do not hook together in any way, except in the primary circuit.

### **3.2.5. Other Aspects of Recharging and Powering Operations**

The invention is deceptively simple in appearance, although its operation is very novel and quite different. The excess charging operation cannot be understood without understanding the negative energy operation and negative energy amplification of the circuit elements. The result is that much more environmental energy has been freely added to the charging operation by re-gauging, than the amount of energy that was input by the operator himself. Because of the excess negative energy freely input from the altered vacuum and particularly by the evocation and use of the E-amp effect, the total energy input to the battery for recharging appreciably exceeds the energy input by the operator.

Because the invention uses negative (converging) energy, typically up to about 300 KW peak power pulses may be utilized for battery charging. With most of this power taken freely from the active vacuum, the battery charges with remarkable speed and with exceptional freedom from wear and tear and normal damage.

By powering an external motor or system from a negative-energy charging battery, the entire battery-powered system can readily provide  $COP > 1.0$  or  $COP \gg 1.0$  operation because the system is freely receiving excess energy input from the active vacuum environment.

To continuously power the  $COP > 1.0$  or  $COP \gg 1.0$  system, one may incorporate two or more batteries, where at a given time one battery is being used in the role of the primary powering battery while the other battery is part of the load and is being recharged by negative energy using this radiant energy charging process. As the primary powering battery begins to decline in performance, the roles of the batteries are switched so that the fully recharged battery is now powering the system while the somewhat drained battery is now being quick charged by radiant energy. In this manner, the overall system is always receiving

excess energy from its environmental energy reservoir, in the form of negative energy used to recharge the batteries (and in the form of the E-amp effect initiated in the various circuit components previously described). The recharging battery portion of the system is also always acting as an energy converter, converting the charging negative energy to stored positive energy for subsequent powering use in the proper switching sequence. As previously mentioned, after several charging cycles batteries charged by the invention also gradually develop their own local E-amp effect.

As previously stated, the small amount of power required for switching can also be made a part of the system's supported load, in which case the system becomes "self-powering" (powered by vacuum energy entirely). The system then exhibits  $COP = \infty$ .

So in this sequential switching method, by incorporating the switching power as part of the system load requirement, a working  $COP = \infty$  system can be continuously and permissibly powered by EM energy freely extracted and converted from the local vacuum.

The SCR may be replaced with a high voltage transistor, a power MOSFET (metal-oxide-semiconductor field-effect-transistor), or a high power IGBT transistor. Using such variations, additional embodiments of the invention have been successfully developed by the inventors. As previously stated, the 555 timing circuit may also be replaced with a common neon bulb. Many other variations are possible, so long as the primary principles of the extraction, amplification, and conversion of negative energy are implemented.

### **3.2.6. Usage with an Elevated External Antenna Collector**

Referring now to Figure 31 on p. 44, a battery may be freely charged with negative energy, day or night, by using the scheme shown. All that is necessary (besides the circuit shown) is that a free environmental source of high voltage must be available.

For use in the circuit of Figure 31, the environmental energy source should furnish high voltage, not high current. As previously stated, for example, there is an environmental potential difference between the surface of the earth and the electrosphere above it, of a nominal 200 volts per meter or more. The voltage per meter, however, varies with daytime or nighttime, with cloud cover, sometimes with the wind conditions, etc.

Referring now to Figure 32 on p. 45, the use of an elevated outside antenna wire as the environmental energy source is shown. The arrangement can freely extract and furnish a potential of 500 to 2,000 volts or higher to a small disc capacitor. The height of the antenna is adjusted so that the voltage desired for the capacitor is what is furnished. Other modifications including an adjustable voltage divider (not shown) can of course be incorporated for greater flexibility and to leave the elevated antenna at a fixed position.

The potential energy flows (see reference 6a, Section 1) comprising the potential across the disc capacitor can be used in sharp pulses to initiate and provide very powerful negative energy flows from the Dirac Sea.

The environmental negative energy received by the system in the pulse discharge is used in very powerful and amplified (via the E-amp process) pulses to rapidly recharge batteries with the radiant energy process of this invention. The active environment furnishes all the required excess energy flow inputs. The battery or batteries may be charged by the radiant energy method, day or night, with nearly zero input of  $dq/dt$  (nearly zero current).

It is accented that most of the energy utilized to charge the battery in the system is re-gauging (change of potential) energy. Hence high potential is useful, but one need not seek high current. Re-gauging involves the potential only, and not the electron current.

This shows the common, ubiquitous error in much of the standard power engineering terminology. E.g., it is not possible to "draw power" from a source. In physics, rigorously power is defined as the rate of doing work. Obviously the "power" is developed in the local component performing the energy dissipation or change of form of the energy (performing work). It is not developed in the flow of energy from the source. The very term "power source" is thus erratically and colloquially used, not rigorously used. To properly analyze a circuit, the energy flow without work (energy transfer without changing its form, which is re-gauging) must be clearly separated from the energy flow with work ongoing (energy transfer wherein its form is also being changed).

### **3.3. Variation of The Radiant Charger Using an SCR**

Referring now to Figure 33 on p. 46, a full diagram of the entire preferred embodiment is shown. Here the three-coil transformer acts as a gate and an E-amp amplifier to increase the excess flow of radiant energy extracted from the active environment. A small "normal"  $dq/dt$  current of about 200 ma maximum is used to trigger a standing potential of radiant spikes. These spikes then alter the local Dirac Sea vacuum in the fashion previously described for the radiant energy battery charging method of this invention. With this alteration, the system is now far from equilibrium with its active external environment, and receiving excess energy freely furnished by that environment, mostly in the form of negative energy. As in a heat pump,  $COP > 1.0$  is now permitted, by the laws of physics and thermodynamics, but the vacuum environment is utilized instead of the ambient atmosphere. Also,  $COP = \infty$  is permitted if the small 200 ma current requirement is made part of the system loading, with necessary regulating controls added (not shown).

The high voltage rectifiers translate this excess negative energy for storage in the storage capacitor as previously described. The capacitor voltage builds very quickly to 200 or more volts. The object is that, during charging operation, only

a potential (though one comprised of negative energy) should be found across the battery, with little or no  $dq/dt$  current flowing.

When one is charging rapidly and high  $dq/dt$  current is flowing, one is charging with positive energy and  $COP < 1.0$  operation. When one is charging rapidly and little or no  $dq/dt$  is flowing, one is charging with negative energy and  $COP \gg 1.0$  operation.

There is in fact a very high current of negative EM energy flowing, in addition to the positive energy electron current  $dq/dt = 200$  ma, and that negative energy current is not a flow of electrons. That high negative energy current is freely furnished from the altered vacuum environment because of the Dirac Sea having been asymmetrically altered by the sharp discharge gradient. This free flow of excess energy (in negative energy form) is not "paid for" by the operator, but is a free input from the active vacuum environment.

Here we emphasize the multiple uses of the word "current" in energy physics. In simple circuits, "current" is usually used to mean a flow of electrons or of other physical charges. However, it is also used to mean a flow of pure EM energy, whether of positive energy or negative energy. It is used to also mean a flow of potential, whether the potential is comprised of positive energy or negative energy. A flow of potential is actually a flow of the altering of the local vacuum potential. Here we are discussing energy flow and we have used "current" to mean a flow of potential and potential energy.

The object is to build a very high voltage across the battery and then gate the SCR for a very high negative-energy discharge, thus evoking very large negative energy current from the altered Dirac vacuum during that sharp gradient. Leading thermodynamicists such as Kondepudi and Nobelist Prigogine have pointed out that sharp gradients are a known area that violates the second law of thermodynamics, although they have not realized that sharp gradients produce momentary bursts and currents of negative energy.

What this known and recognized "violation of the second law of thermodynamics" means is that strong gradients can and do sharply break equilibrium and produce *negative entropy*, normally excluded by the overly restrictive form of the second law which assumes equilibrium (condition of maximum entropy). The sharply pulsed system is a nonequilibrium system strongly receiving excess negative energy from its active and altered Dirac Sea environment. In the methods advanced in this invention, we deliberately utilize the free negative energy thus obtained from the altered Dirac Sea, and we do not destroy it in strong system common grounding (as is the common practice).

Such alteration of the Dirac Sea—to lift and hold excess electrons from their holes and leave the remaining temporary 4-holes—does occur during all strong EM pulse discharge gradients. This is particularly true when only minimal electron currents are permitted in the pulse discharge gradients. However, the conventional closed current loop circuitry so favored by electrical engineers uses

common grounding, forcing the immediate interaction of the freed Dirac Sea 4-holes with the material lattice of the ground conductors to produce positrons. In the (momentarily) strongly curved spacetime in that pulse discharge, the 4-holes immediately “eat” negative charges in the material lattice of the grounding, usually without pair annihilation radiation. Rather than being radiated, the excess energy from pair annihilation is mainly consumed by the relaxation of the curvature of the spacetime (by the re-gauging of the previously curved spacetime itself).

This immediate lattice absorption process due to conventional use of a common ground thus eliminates any effective use of negative energy and negative energy environmental amplification. It produces the excess lattice positive charges now called “positrons” (particularly in semiconductor theory). These positrons—created after 4-hole interaction with the lattice material during the discharge itself, and after disappearance of the actual unfilled 4-holes—are erroneously also called “holes” in the semiconductor literature. *They are not negative energy Dirac Sea 4-holes in vacuum at all, but only “holes” in the sense of absences (missing electrons) in the Drude electron gas*, because they have been transduced (by interacting with the material lattice) into positive mass, positive energy source charges, and they emit positive energy EM fields and potentials.

At any rate, the method of strong common grounding during the switching process itself “makes or breaks” the ability of the circuit or system to have temporarily persisting real Dirac Sea unfilled 4-holes and thus to have the freedom to apply the radiant energy methods of this invention. Common grounding practice, if meticulously followed, kills the 4-holes almost instantly as well as the negative energy and E-amp effect, leaving behind the lattice positrons with positive energy. From there on, the conventional circuit only involves a flow of normal  $dq/dt$  and normal divergent EM Poynting positive energy flow. In that case, all excess negative energy being freely received from the vacuum is deliberately and immediately shorted to ground and converted into the normal entropic (diverging) energy form, resulting in the normal entropic engineering used in all other conventional circuits and their common  $COP < 1.0$  operation.

When the capacitor discharges to the battery level, the SCR will turn itself off, because in the case of using *negative energy* the polarity for this device must be reversed in order to function as desired. If more current  $dq/dt$  were developed by the oscillator, the system would not work because the SCR would stay on. However, since this device optimizes “negative energy field” flow and “negative energy potential” flow, then positive energy  $dq/dt$  current is not materially present. Hence, the SCR will turn off in a standby mode until the next cycle, which is necessary for the negative energy operation and negative entropy (E-amp) operation. As a variant, the SCR may be removed from the circuit and a transistor or a FET may be put in its place.

Since appreciable *negative* energy is being used in the invention, the battery pushes the ions to the “opposite from normal” recharging plates of the battery. The “sign” on the plate potentials is also as if momentarily reversed. A battery may be considered as a difference in potential, and the total potential across the battery is reversed from normal polarity because of the semiconductors used. In other words, the negative terminal for positive energy becomes positive in *negative energy* potential so that the semiconductors used will trigger this negative energy voltage oppositely from their operation in a normal condition. This inversed operation releases a sharply discharged radiant energy flow into the battery when the SCR or other devices are triggered. When viewed with normal instruments designed for measuring positive energy, this energy flow appears in the form of a very sharp negative energy spike. There is indeed a rather massive flow of “current”, but that current is in the form of electron-free negative energy fields and potentials from nearby Dirac Sea 4-holes, and said negative energy is implisively charging the battery.

On a charge that the positive energy field pushes, the negative energy field pulls. So the negative energy forces must be applied to the battery precisely oppositely in polarity to their positive energy “brethren”. A charging battery or capacitor does not care whether the ions are “repelled from” one plate or “attracted to” the other plate.

As an embodiment example, the radiant energy charging process might introduce a negative energy flow current to the battery that is *equivalent* to 300 volts and from 500 to 1,000 “amperes”. The impulsive negative energy goes into the battery very rapidly, recharging occurs, battery cooling and electrolyte “boiling” motion occur without any overheating, and the battery chemistry is restored to a good state much like that of a charged new battery. *Not* observed are: arcing, popping, overheating, violent movements of the battery, frothing, boiling over, strong gas emissions, melting, and so forth.

Positive energy is divergent and therefore dissipative, heating, and entropic. To the contrary, negative energy is convergent, cooling, and negentropic. As previously stated, impulsive negative energy pulses can also be quite beneficial in often reversing much of the previous deterioration of the battery from positive energy battering.

Further, to provide 300-kilowatt peak power pulses of *positive* energy, the operator would have to pay a very substantial price to input and prepare the positive energy required. But to provide 300-kilowatt pulses of *negative* energy being freely received from the altered vacuum, the operator only has to pay a few watts for switching and timing, since the negative energy is freely received implisively from the altered vacuum, and rather automatically amplified by taking advantage of the natural E-amp processes of the impedances in the circuitry itself.



### **3.4. Monopole Motor Powered by Radiant Energy Charger**

Referring now to Figure 34 on p. 47, a schematic of a monopole motor powered by the radiant energy charger process of this invention is shown.

As can be seen in Figure 34, three batteries are utilized in this particularly variation, with in-and-out switching so that one battery is used to power the circuit in normal fashion while two other batteries are being simultaneously recharged very rapidly by the radiant energy process using negative energy charging rather than positive energy charging.

The great advantage is that this process is in the  $COP = \infty$  or "self-powering" mode. (Actually, as previously mentioned, it is powered by energy freely furnished from the active external vacuum environment, analogously to a solar cell powered by its observable solar radiation environment or to a conventional hydroelectric power plant and its industrial grid, when the free flow of water energy from the river is accounted.)

In this process used by the invention, the energy is received from the active and altered Dirac Sea, in the form of excess negative energy input. It is used to implosively charge the recharging two batteries very rapidly, where their recharging is considered just a part of the system load, in addition to the mechanical load (not shown) that is placed on the shaft of the monopolar motor. After some period of operation, a part of the input to the two batteries comes from their own "gradually conditioned" E-amp and negative resistance effect.

Any other kind of normal electrical load could be substituted for the monopolar motor shown. In addition, any normal shaft load can be added to the motor and powered by it.

As an example, the shaft load of the motor can be a conventional generator, so that this system then becomes a self-powering electrical power generating system for remote use or for emergency use where a power line is unavailable or the power has failed. As such, it is highly suitable for powering remote homes and as an emergency backup power source for less remote homes when the power system or power grid fails (as in large power outages experienced in 2003 in the U.S., Spain, Italy, etc.). It is also suitable for remote system operation such as in the Arctic or Antarctic, or in remote buoys etc.  $COP = \infty$  mode is highly advantageous in that the operator need not furnish any petrol or other fuel, or have a large windmill handy or a hydroelectric dam handy. Instead, all required input energy is being freely received from the active environment. Hence, it is of very great advantage when commercial power is lost due to such calamities as large forest fires (experienced heavily in the West in 2003), tempestuous storms such as hurricanes, tornadoes, and large ice storms (somewhat frequently encountered these days). Its advantage in case of biological warfare strikes by terrorists (part of our standard national threat, and definitely to be expected in the future) is obvious. In a great emergency, conventionally fueled back-up electrical power generation systems may not be able to depend

upon necessary supplies of fuel. In  $COP = \infty$  radiant energy powered generating systems, it is as if the fuel source, the fuel distribution system, the refining system and petrol distribution system, and the on-site fuel storage system have all been replaced and incorporated into a single local circuit and system. All those ancillary functions so necessary to electrical power generation are automatically furnished by the radiant energy system and process of the invention in  $COP = \infty$  mode.

### **3.5. Using Earth Cells with the Potential Switch and a Transistor**

**Figure 35** on p. 48 shows how the invention's potential switch can be hooked up to charge storage batteries from earth cells, where earth cells are slight differences in potential that are found on the surface of the earth itself and just beneath that surface. By placing several earth cells in series, the voltage may be raised (say, from a half volt to 20 volts). The earth cells supply only a potential of 20 volts with very minimal current of 50 to 200 milliamperes. In short, one watt to a few watts may be taken as the power coming from the earth cells and input to the system. This 20 volt potential is across the battery to the transistor switch. When the 555 timer circuit switches, the capacitor is discharged across the battery. In conventional positive energy, the discharge from the capacitor would be very little. However, as it discharges, the gradient forms an asymmetrical vacuum, so that suddenly the capacitor is discharging negative energy amplified by the E-amp effect in the capacitor itself, and the receiving battery is further amplifying the received negative energy by the E-amp effect. The result is that the battery is more rapidly charged with negative energy—an excess of which is freely received from the local asymmetrical vacuum via the E-amp effect. Further, the charging of the battery also transduces the negative energy into normal positive energy, so that the battery can then be discharged to power loads normally.

### **3.6. Embodiment with an Inverted Potential Switch**

Referring now to **Figure 36** on p. 49, a final illustrative embodiment of the invention is shown with an inverted potential switch. To the battery, the switch appears as a load in the collector whenever the capacitor voltage exceeds the battery voltage by one volt. When the signal from the 555 timer goes high, the opto-coupler turns on and the capacitor is discharged across the battery in asymmetrical local vacuum exchange fashion, taking full advantage of the excess negative energy available and received via the E-amp effect.

The timing may be set by the 555 timer by adjusting the resistors that make up the timing loop. The semiconductors must be chosen for the correct voltage range. The semiconductors may be MOSFETs, transistors, IGBTs, SCR's, or other semiconductor found to work well with negative energy. Mechanical commutation of any kind can also be utilized.

The input can be coupled to any source that can generate high voltage spikes. Examples include inductive oscillators, inductors, DC-to-DC converters, solar cell panels, HEI systems, generators, earth cells, salt water cells, batteries, electrets, inverters, or anything that can furnish the initial small watt or so to initiate the negative energy charging of the capacitor by the asymmetrical local vacuum.

As can be seen, in this embodiment and similar, the invention can be used as a very substantial coefficient of performance (COP) amplifier for any other appropriate type of system having the necessary EM output. In that function the invention takes full advantage of the asymmetric vacuum, its free supply of excess EM negative energy, and the E-amp effect. The COP amplification function is unique to the invention, and has great application as is readily apparent to power engineers. Its application to the powering of remote systems is readily apparent, in that it is analogous to applying a very high COP "heat pump" approach but taking most of the powering energy from the local active vacuum, in an application where presently only purely resistance heating is being used.

The inverted potential switch has also been modified to optimize the receipt of additional negative energy through the E-amp effect, but that will be the subject of a separate Provisional Patent Application.

## Section 4: Advantages

There are many advantages of the present invention. A system advantage is to:

- 4.1. Provide a very efficient, very fast system and process for recharging batteries easily and very quickly, at a COP > 1.0 so that very little input power is furnished by the operator, while the remainder of the input power is furnished by the local environment.
- 4.2. Provide a process for recharging batteries with little input power by the operator, and where the extra input power utilized is in the form of negative EM energy input freely received from the altered local Dirac Sea of the active vacuum.
- 4.3. Provide an electrodynamic power-producing and energy collecting process that utilizes as its major or total energy input the negative energy from un-filled Dirac Sea holes produced in the local Dirac Sea, where said negative energy is further amplified by environmental amplification (E-amp) processes, immediately evoked in resistive and inductive sections of the system circuitry, and increasingly evoked after an operational time delay in capacitive sections.
- 4.4. Provide a battery-charging system wherein the battery is charged by strong negative energy pulses of up to multi hundred kilowatts peak power, and where said battery is used as a collector-receiver of the negative energy pulses, and where the battery further acts as a transducer of the received negative energy into positive energy, and where said positive energy is then stored in the battery to be furnished to power external circuits and systems. It is noted that many combinations of timing the charging and discharging of the battery can be utilized, to include simultaneous charging and discharging where the discharging is to power some part of the circuit or system or all of it.
- 4.5. Provide a battery-charging system wherein the battery is charged by strong negative energy pulses of multi hundred kilowatts peak power, and where said battery is used as a collector-receiver of the negative energy pulses, and where after a period of operation said negative energy pulses are further amplified by the conditioned negative resistance and E-amp effect developed by the operating battery, and where the battery further acts as a transducer of the received negative energy into positive energy, and where multiple batteries are employed, and where some batteries are used in powering mode while other batteries are freely charging, and where re-charged batteries and discharged batteries are periodically switched, so that continuous electrical power is maintained.
- 4.6. Provide the capability in 4.5 where the dual usage of batteries in the same system and circuit, together with effective switching, provides a negative

energy to positive energy converter, and where the input energy to said energy converter is in the form of negative EM energy freely received from the local altered Dirac Sea of the active vacuum.

- 4.7. Provide a capability for converting a battery-charging system into a system far from equilibrium in its energy exchange with its local active vacuum environment, so that said system becomes a system far from equilibrium, thus permitted to exhibit  $COP > 1.0$  even though system efficiency  $\xi$  is always  $\xi < 100\%$ .
- 4.8. Provide a capability for converting a battery-powered system into a system far from equilibrium in its energy exchange with its local active vacuum environment, so that said system becomes a system far from equilibrium, thus permitted to exhibit  $COP > 1.0$  and even  $COP = \infty$ , even though system efficiency  $\xi$  is always  $\xi < 100\%$ .
- 4.9. Provide a system process that utilizes as its primary energy input the negative energy flow from an altered Dirac Sea vacuum having unfilled Dirac Sea holes (negative energy 4-dimensional electrons, prior to their interaction with mass and thus their observation as positrons).
- 4.10. Provide a battery-charging system and process wherein when the charging circuit is removed, the battery voltage does not drop back as quickly as a battery after recharging by a conventional prior-art recharging system, because previous deteriorations in the battery from prior usage are corrected or partially corrected, and because of the E-amp conditioning of said battery over its previous operation time.
- 4.11. Provide a battery-powered system wherein said system freely extracts and receives excess positive and negative energy from its local Dirac Sea, and uses said extra environmental energy input to power the system and its loads and losses while continually recharging batteries for switching into powering mode, thus converting the overall system to an environmentally powered (self-powered) system analogous to a system powered by a solar cell array, a windmill-powered generator, or a hydroelectric generator so that the overall system is freely powered by energy freely received from the external environment.
- 4.12. Provide a system as in 4.11 wherein said negative energy is furnished to said battery in very powerful pulses for rapid charging, with improved safety, and where said pulses are in the hundreds of kilowatts of peak power range. It is again noted that, in scaled-up or scaled-down systems, this peak power range may be substantially reduced or substantially increased, as the application warrants.
- 4.13. Provide a battery-charging system and process whereby effects of one cell in the battery being electrochemically weaker than the other cells in said

battery are minimized because related adverse chemical effects are reversed and thus bypassed.

- 4.14. Provide an improved process for equalizing a battery comprised of a plurality of electrochemical cells, wherein the cell with the highest resistance, which in a normal battery charging operation limits the charge that all of the cells of the battery can take, is instead the cell that receives the greatest charging effect, with negative energy converging more strongly on the cell with higher resistance, and with the higher resistance acting as a higher environmental amplification (E-amp) effect, such that the condition of the initially defective cell is quickly mended.
- 4.15. Provide a system as in 4.11 and 4.12 and 4.14, wherein standard circuit elements such as resistances and inductive couplings are utilized as immediate negative energy environmental amplifiers (E-amps), and where inductive circuit elements develop E-amplification after an operational period, and where the excess amplified negative energy is freely furnished by the altered external Dirac Sea, so that the entire system becomes a thermodynamic system far from nonequilibrium, freely receiving and utilizing excess negative energy from its vacuum environment, and also transducing said negative energy into positive energy, and further collecting said excess positive energy as excess potentialization of said batteries, and further dissipating said excess positive energy and excess potentialization by doing work in the circuits and their internal and external loads.
- 4.16. Provide a battery-charging system and process whereby the battery is brought up to full charge (and a slight overpotential) much more quickly than in conventional charging, and in a manner impossible to achieve by the energy furnished by the operator alone, but requiring excess negative energy furnished by the external active environment.
- 4.17. In addition to the battery charging function, provide an overall electrodynamic generator and power-producing process that is an open dissipative system not in thermodynamic equilibrium, freely receiving, gating, and using energy from the altered Dirac Sea as its active external environment.
- 4.18. Provide an electrodynamic generator and asymmetrical self-re-gauging system and power-producing process that freely and asymmetrically re-gauges batteries, capacitors, and systems by receiving excess energy transfer from the external vacuum environment, thereby increasing the re-gauged system's potential energy asymmetrically and freely except for switching and control costs, so that said regauged system can then dissipate its excess energy in useful loads, producing excess useful power and work beyond what the conventional energy input by the operator could accomplish.
- 4.19. Provide a battery charging system and process, and an electrodynamic generator and power-producing processes that do not produce radioactive

- or chemical wastes, harmful exhausts, unwanted radiation, or pollution byproducts into the environment.
- 4.20. Provide a battery charging system and process, and an electrodynamic generator and power-producing process, for powering useful loads and accomplishing useful work, where said system and process does not require a supporting fuel transportation chain such as trucks, ships, trains, aircraft, tankers and such which themselves consume fuel and produce harmful by-products, emissions, and pollutants into the environment. Instead, the system only requires the local energetic vacuum and curved spacetime.
  - 4.21. Provide a battery charging system and process, and electrodynamic generators and power-producing systems and processes that are simple and economical to manufacture and mass-produce, using standard parts and standard construction and manufacturing methods.
  - 4.22. Provide a battery charging system and process, and an electrodynamic generator and power-producing process that contains and uses negative energy environmental amplifiers (E-amps), thereby increasing and amplifying the inflowing and input of negative EM energy from the environment.
  - 4.23. Provide a system as in 4.22 that utilizes a process and method for forming persistent Dirac Sea holes as negative energy electrons and source charges, in its immediate active vacuum environment.
  - 4.24. Provide a system as in 4.23 wherein the fields and potentials from the persistent Dirac Sea holes are negative energy EM fields and potentials.
  - 4.25. Provide a system as in 4.24 wherein the negative energy EM fields and potentials are utilized in powerfully amplified pulses of negative energy.
  - 4.26. Provide a system as in 4.25 wherein said amplified pulses of negative energy are directed into a receiving battery or capacitor to rapidly charge it.
  - 4.27. Provide a system as in 4.26 wherein the rapidly charged battery or capacitor converts its input excess negative EM energy into normal positive EM energy and stores it as conventional excess potential EM energy in said battery or capacitor.
  - 4.28. Provide a system as in 4.27 wherein the transduced energy stored in said battery or capacitor is then dissipated normally to power circuits or systems or loads or a combination thereof.
  - 4.29. Provide a system as in 4.28 wherein said powering system simultaneously uses a part of the excess negative energy input from the environment to recharge additional batteries, simultaneously with powering the circuits and systems and loads.

- 4.30. Provide a system as in 4.29 wherein said recharging batteries are periodically switched into position as powering batteries for said system, while previous powering battery or batteries are switched into recharging position via some of the excess negative energy input from the environment.
- 4.31. Provide an electrodynamic battery charging system and process, as well as a generator and power-producing system and process that contain sensors and pulse generators and control mechanisms, thereby to initiate electromagnetic self-switching and self-oscillation, and simultaneously altering its external environment to form Dirac holes as source charges producing negative energy EM fields and potentials, and receiving said environmental negative EM energy and collecting and transducing it into positive EM energy, and dissipating said positive EM energy to power the system and its loads and losses, without any energy input separately by the operator, thereby producing a "self-powering" electromagnetic system and generator furnishing electrical power to an external load, while switching batteries between powering and recharging functions, thereby enabling continuous self-operation of the system using energy freely input from the external active environment, so that the operator need not furnish any of the input energy.
- 4.32. Provide an open electrodynamic system and power-producing process and system that is free running, while powering an external load.



# FREE ENERGY GENERATION

---

## Section 5: Other Advantages

Several additional advantages of the invention are:

- 5.1. An embodiment allows a small input of normal EM energy by the operator, from an external power source that the operator pays for, to gate the inflow and usage of a larger amount of energy from the active vacuum environment, in a manner analogous to the operation of a common home heat pump gating receiving excess energy from its atmospheric environment, so that  $COP > 1.0$  is produced by the system even though the system's overall efficiency  $\xi$  is always  $\xi < 100\%$ .
- 5.2. Other embodiments allow all the required energy to be received from the active external vacuum environment, in a manner analogous to a solar cell array powered system receiving all its energy from its solar radiation environment, so that  $COP = \infty$ , even though the system's overall efficiency  $\xi$  is always  $\xi < 100\%$ . In this way, once the system is up and operating stably, the operator's start-up furnishing of energy can be discontinued and the operator need furnish no additional energy input.
- 5.3. In  $COP = \infty$  operation, the energy flow utilized to power the load and system losses is extracted from the active vacuum flux in negative energy form, by providing a sharp gradient in said vacuum flux, thereby momentarily lifting electrons from the Dirac sea and leaving unfilled holes, which in turn act as source charges and provide negative energy flow into the system and along its conductors and components. In a capacitor or battery or both, the system collects the freely furnished negative energy and transduces it into normal EM positive energy, and then the system discharges the freely collected excess energy as normal positive energy to power the circuit's loads and losses. Specifically the system utilizes the first-formed form of the Dirac Sea holes, prior to their interaction with matter to generate lattice positrons and lattice positron currents, the latter being used in standard solid state theory and electrical circuit theory.
- 5.4. The initial imposition of the Lorentz condition (use of half the collected energy to drive load current back through the primary source dipole and destroy its dipolarity) is avoided by the invention, since most of the EM energy flow passes from the external vacuum directly into the circuitry in negative energy form, being amplified in the resistances and inductive components (and gradually in the capacitive elements) as the environmental amplification (E-amp) process, and thence being introduced to a battery or capacitor to rapidly recharge it, simultaneously changing the received excess negative energy into excess positive energy collected in said battery or capacitor, and then discharging said stored positive energy as real energy powering loads and losses in a conventional manner.

- 5.5. The device and various embodiments can be made quite rugged, can easily be environmentally shielded, and readily operates in environments that are hostile to standard electric generators and battery-powered processes. It can, for example, be ruggedized to withstand accelerations such as 50 g or more.
- 5.6. The device produces useable electric power without any adverse environmental effects, harmful emissions, or creation of pollutants.
- 5.7. The device produces useable electrical power without any waste byproducts requiring storage, disposal, or dumping.
- 5.8. Because of the "healing" process generated in batteries and capacitors charged with negative energy, batteries and capacitors have their mean time between failures (MTBF) increased. Hence, they last appreciably longer than in conventional charging and discharging systems, thereby reducing the quantity of spent batteries and capacitors to be replaced and disposed of.
- 5.9. In  $1.0 < COP < \infty$  variations, the system dramatically reduces its use of external electrical power requiring the burning of hydrocarbons, depletion of nuclear fuel rods, building of hydroelectric dams and windmill farms, solar cell array powered systems, etc. It also reduces fuel processing, transportation, loading and handling, and fuel usage costs.
- 5.10. In  $COP = \infty$  variations, the system requires no fuel (input of external energy) other than the input of negative energy from its local vacuum environment, thereby eliminating any use of external electrical power requiring the burning of hydrocarbons, depletion of nuclear fuel rods, building of hydroelectric dams and windmill farms, solar cell array powered systems, etc. It also eliminates the associated external usual fuel processing, fuel transportation, fuel loading and handling, and fuel usage costs.
- 5.11. If for some reason the system mechanically breaks or is abandoned, all parts are readily reprocessible and reusable.
- 5.12. The system is readily produced from normal parts and other normal subsystems, by normal manufacturing processes and installations already extant.
- 5.13. With the iterative switching of recharged batteries into powering mode, and discharged batteries into recharging mode, and with self-recharging, the mechanical motion and its induced friction usually associated with rotary generator devices for this primary power function allows the device a longer useful life cycle and greater reliability.
- 5.14. The device and process can readily be scaled up, so that a range of generators of various power levels can be produced.

- 5.15. The system and process enables ready and quick completion of some projects and systems presently either very difficult or impractical to produce. Examples are the practical (self-powering) electrical automobile and other uses in transport, including trucks and aircraft. Remote power systems requiring frequency fuel replenishment etc.—such as remote buoys and warning lights—can now be operated in  $COP = \infty$  format, with greatly reduced maintenance and servicing costs and with increased mean time between failures. Redundancy can also be built in, to further increase mean time between failures, and to provide higher reliability.
- 5.16. The device and process can be readily made self-timing and self-switching.
- 5.17. Operation and maintenance of the device and process are simple and economical. Training of operators and maintenance personnel is simple and economical. No highly specialized technical personnel are required. Stockage and storage of spare parts are minimized.
- 5.18. The elimination of hazardous wastes and harmful byproducts dramatically reduces the pollution of the biosphere per megawatt of power produced. As this device and system is used in an increased fraction of power-producing applications, the pollution of the biosphere per megawatt of power produced will also be dramatically reduced. As increasing use of this generator is phased in world wide, the beneficial effect on the environment is further augmented by the dramatic decreases in hydrocarbon fuels burned, nuclear wastes produced, nuclear fuel produced, and contamination and pollution produced by transporting and handling systems and processes.
- 5.19. The elimination of fuel, fuel transport and handling, and supporting fuel transportation means, allows the  $COP = \infty$  variants of the system and process to be used in remote applications that are challenging for conventional power units and difficult to resupply with fuel, and also eliminates the waste byproducts, pollutants, and financial costs associated with the extensive present fuel transport and support systems.
- 5.20. The unit is readily adaptable for undersea, space, airborne, and land-based applications. Under the great advantages for remote operations, applications in space, naval task forces on distant station, battery-powered submarines, etc. are particularly benefited by usage of the system and process.
- 5.21. Many electric power companies are presently installing enormous batteries (building sized) to store excess power during lesser drain periods, using that excess power capability when transient or temporary increases in energy demands are encountered. By scaling up and applying this system and process, the very large investment in such a large battery can be extraordinarily capitalized by having it also become a  $COP = \infty$  generator fa-

cility, freely extracting its charging and recharging energy from the local altered Dirac Sea and dramatically lowering electricity costs.

- 5.22. Scaled up units are adaptable for powering a variety of applications such as vehicles, houses, offices, factories, offices, buildings, ships, trains, trucks, remote installations, aircraft, and undersea craft.
- 5.23. Reliability of electrical utility systems can be increased by incorporating this system, particularly in a new mix of decentralized power generation systems and a significant fraction of customers who utilize local power systems based on this system and process. The conventional centralized power system with its vulnerability to sunspot activity, magnetic storms, electromagnetic pulse, acts of God, natural catastrophes such as earthquakes, fuel embargoes and shortages, acts of sabotage and war, violent storms and tornadoes, and an extremely poor control system not unitized as a single system, etc. is transformed to a mix of centralized and decentralized systems. The redundancy of these systems assures electrical power survival and endurance under adverse conditions, and assures only gradual and graceful degradation of electrical power in the face of destruction or damage, rather than catastrophic failure as experienced in 2003 in the Northeast U.S., Spain, Italy, and elsewhere. Vulnerability of such a “mixed centralized and decentralized” power system to large electrical power grid failures, sabotage, and acts of war is dramatically reduced.
- 5.24. The reduction of atmospheric pollution, harmful byproducts, hazardous wastes, and disposal problems associated with the present hydrocarbon-powered vehicles will be of incalculable benefit worldwide. E.g., the replacement of small inefficient 2-cycle and 4-cycle fueled engines with E-amp powered battery driven electrical motors will remove a major cause of much atmospheric pollution by unburned hydrocarbons from these inefficient systems utilized worldwide in large numbers. Replacement of coal-burning plants and diesel-powered transport will dramatically reduce the emissions of soot into the environment, thereby dramatically reducing global warming since soot has now been implicated as one of the primary causes of global warming.
- 5.25. Use of new superbatteries in this device and process, incorporated to drive electric motors in automobiles, will enable practical, economical, high performance electric cars that are agile and have a range limited only by mechanical maintenance considerations and mechanical breakdowns. A smaller mix of batteries can be used, where some of the batteries are being recharged while the others are powering the vehicle.
- 5.26. The elimination of fuel, fuel transportation, fuel packaging, and fuel storage will provide an epochal economic advantage of incalculable financial benefit at every level of society, dramatically lowering the cost of en-

ergy world wide and substantially easing the provision of electrical power anywhere.

5.27. Manufacture of the units using the process is simple and straightforward. It uses standard equipment and assembly, with relatively unskilled labor.

5.28. Maintenance of the generator units is simple and straightforward, and—for example—far simpler than maintaining an automobile or a chain saw.

Many other advantages of the radiant energy charger and process have not been enumerated above, but the foregoing listed advantages together with the objects of the invention and other advantages appearing in the background section suffice to show the highly beneficial impact of providing electrical power systems fueled partially or totally by energy extracted from the local vacuum, in a wide variety of applications.



## Section 6: Remarks on Potential Claims

In the later formal patent application, the claims will be prepared by a professional patent attorney skilled in the necessary electromagnetic and electrodynamic arts and the necessary physics. In the preceding list of objects, advantages, and additional advantages, as well as additional advantages appearing in the background sections, we have listed many of the obvious bases for claims that readily come to mind. Due to the novelty of the invention and the energy from the vacuum process, the reader will see there are bases for many other claims involved. These will be legally and properly formulated by our patent attorneys in the final formal patent application.

To reiterate some of the special features that provide bases for claims: These special features include:

- 6.1. Alteration of the local Dirac Sea by inducing sharp gradients and asymmetry, so that excess electrons are lifted from the Sea and largely held in place, leaving Dirac Sea holes as negative energy source charges (negative energy electrons) freely pouring out negative energy EM fields and potentials. Hence, excess negative energy is freely received from the environment.
- 6.2. Curving the local spacetime by inducing sharp energy discharge gradients, so that curvatures of spacetime act on the local vacuum to produce effects as in 6.1 above. Said curvatures of spacetime then interact back upon the system itself as well as the local Dirac vacuum. In this way, the system uses a process which affects all three components of the supersystem, including (i) the system and its dynamics, (ii) the local vacuum and its dynamics, and (iii) the local spacetime and its curvatures and dynamics. In this way, the invention is the first method, system and apparatus which deliberately alters its own external vacuum environment and spacetime curvature environment so as to change the system into a far from equilibrium system, freely receiving and using excess energy including negative energy from said altered external environments.
- 6.3. Use of negative energy flow that in turn automatically generates negative impedances (negative energy flow amplifications) and extra environmental energy flow inputs of negative energy immediately at normally resistive and inductive elements of the circuitry and after an operational time increasingly at normally capacitive elements of the circuitry. This has the additional advantage of dramatically changing the present universal entropic engineering—i.e., as if a circuit or system were a “leaky diode” where energy is input, some of it is lost to the external environment in passing through the diode, and less energy is output from the diode. Instead, using negative energy and the E-amp effect, negentropic engineering is accomplished—i.e., as if a circuit or a system were a triode, where



the input power to the cathode is freely furnished from the environment, the operator need furnish only a small gating and control "grid" signal, and a powerful flow of energy from cathode to plate and output power from the plate is controlled by input of only a small grid power. Further, a governed feedback from the output can be utilized so that the grid power is also freely furnished, and the system becomes "self-powering" with  $COP = \infty$ .

- 6.4. Use of a 1:1 transformer as an environmental amplifier of negative energy flowing in the circuit, wherein excess negative EM energy freely enters the circuit from the active and altered vacuum in each transformer inductive coupling.
- 6.5. Use of resistive, inductive, and capacitive circuit elements in a new manner, as environmental amplifiers of negative energy flowing in the circuit, wherein additional excess negative EM energy freely enters the circuit from the active and altered vacuum at each inductive or resistive element immediately and at each capacitive element after an operational conditioning time delay.
- 6.6. Use of work-free re-gauging of the local vacuum itself, to convert it into a free environmental source of excess EM energy and excess electrons.
- 6.7. Use of converging EM energy (negative EM energy) rather than diverging EM energy (positive EM energy) so as to pass far greater energy currents and pulses through the circuit and along a conducting element, than is possible in a "positive energy only" circuit and system. The capability to pass large amounts of converging energy down relatively small conducting sections allows small systems to generate, handle, and utilize very large power pulses, including in the hundreds of kilowatts range.
- 6.8. Process and variations are readily scaled up in size, and also are readily scaled down in size. E.g., the invention can be miniaturized to provide self-charging battery power supplies for computers, with long life and little or no maintenance, which would have a dramatic effect upon lab tops, portable computing machines, remote small data processors, etc.
- 6.9. Process and variations to freely alter pre-force (massless) causative EM fields and potentials in space as they actually exist in mass-free form. Since these causative EM fields and potentials act upon the system to produce all forces in the system, the invention is the first system that freely alters pre-force causal entities, which then freely change the forces which are acting upon the system to drive it.
- 6.10. In accord with 6.9, the invention is the first system which engineers force-field-free precursors of force to freely and asymmetrically regauge itself and change its potential energy, converting its external vacuum and space-

time environments into work-free energy sources freely adding additional potential energy and field energy to the system for its use.

- 6.11. The invention deliberately violates the common ground closed current loop circuit practice used in electrical power systems, in order to break the symmetrical self-re-gauging of the said closed current loop circuit, and thus becomes a system far from equilibrium with its external active environment, so that said active environment can and does furnish net excess energy to the system in asymmetrical form rather than in symmetrical form. Of particular interest and use is the copious negative energy thus freely received from the environment.
- 6.12. The invention is the first system that freely alters the forces affecting and driving it, by freely altering the pre-causal entities that generate the forces themselves. In this way, the system functions as a nonequilibrium system, and it can and does produce negative entropy operations as well as entropic operations. When the negative entropy operations equal the entropy-producing operations, the system is said to be "self-powering" which means it is completely powered by energy from its active external environment and exhibits  $COP = \infty$ . No other electrical power system deliberately develops and utilizes such negentropic operations for such purposes.
- 6.13. The invention is the first system to charge batteries and capacitors with implosive (convergent) negative energy rather than explosive (divergent) positive energy, thus allowing far more rapid charging of batteries and capacitors without damage.
- 6.14. The system potentializes in static potential flow form as a negentropic operation, and then depotentializes (dissipates) energy dynamically to power loads and losses in entropic operation.
- 6.15. The system uses common circuit elements, such as resistive elements and inductive elements immediately and capacitive elements after an operational time delay, to also function as negative energy amplifiers, freely powered by the external active environment in negentropic fashion.
- 6.16. The system uses the principle that almost unlimited potential energy flow and asymmetrical re-gauging are available from even small dipolar sources of potential, and it applies the principle by collecting the energy while in a positive-energy current-free mode, and partially in a negative-energy current flow-magnifying mode.
- 6.17. The operation of the system is not modeled by the standard electrical engineering model, since that model erroneously assumes an inert local vacuum and a flat local spacetime. Both standard model assumptions are violated by the invention, which uses both an active local vacuum and a curved local spacetime to provide free, excess EM energy to the system.

- 6.18. The system violates the usual thermodynamics assumption of an equilibrium system. To the contrary, the invention deliberately employs a system far from equilibrium in two simultaneously active external environments: the active local vacuum and the active local curvatures of spacetime.
- 6.19. The invention violates and extends the functioning of a normal electrical power system, which uses only positive energy. The invention deliberately employs a mix of positive energy and negative energy, and deliberately exploits the unusual characteristics of negative energy and free environmental amplification thereof.
- 6.20. During its powering (potential energy discharge) operation, the system isolates the original dipolar source of potential energy from the normal back emf detrimental operations. The normal back emf energy drains are only allowed to drain secondary potential energy collections, which have been freely created in the system by energy flow input from the external environment. The original dipolar converter of the energy from the vacuum environment is isolated from common system ground during the dissipation and powering cycle. It is also isolated during the special charging cycle, so that the normal back emf limitation and forced symmetrical re-gauging does not occur. In this manner the invention can permissibly exhibit  $COP > 1.0$  or  $COP = \infty$ .
- 6.21. Under steady powering conditions, thermodynamically the invention functions on the average as a nonequilibrium steady state (NESS) system freely receiving and using excess energy from its active environment(s).
- 6.22. The invention is deliberately designed to permissibly violate the present classical equilibrium second law of thermodynamics, by functioning in a far from equilibrium and sharp gradient manner already recognized and proven to violate said second law, as clearly stated by leading thermodynamicists such as Nobelist Prigogine.
- 6.23. The invention meets the criterion that "*If the solution is not affordable, it is not a solution.*" Many present "solutions" being pressed by the scientific and power communities are not really affordable. These include fuel cells (a nightmare when scaled up, tricky and dangerous, and still requiring fuels), nuclear power plants (the nuclear waste problem is already overpowering and unsolved, and it takes three quarters of a decade to build and activate such a plant at tremendous expense), cheap coal burning (requires relaxing of environmental standards and increased damage to an environment already heavily damaged and reeling, particularly when the impact of rapidly increasing demand from nations such as China are considered). In contrast, the invention solves the environmental problems (no harmful hydrocarbon byproducts or radioactive wastes, etc.), and is economically very attractive when compared to other proposed solutions. In addition, it has the advantage of dramatically reducing the degree of hydrocarbon fu-

els burned, and the nuclear fuel rods consumed, and the needs for additional pipelines and power distribution lines, even as it picks up increasing deployment at the outset. As another advantage, its use of negative entropy processes as well as positive entropy processes adds cooling as well as heat output, reducing the waste heat released into the biosphere and decreasing the impact on global warming.

- 6.24. The invention further meets the criterion that "*If the solution is not timely, it is not a solution.*" Again, many present solutions being pressed are not timely at all. The scientific community has spent billions and 50 years on pursuit of hot fusion, which has not added a single watt to the power line and is not likely to do so for at least another 50 years. The Department of Energy has in fact listed its fusion effort as its first huge new priority (Science, Vol. 302, 14 Nov. 2003, p. 1126), even though hot fusion is still not considered achievable for perhaps another 50 years. Fuel cells, now being funded and pursued magnificently, will not be truly practical for some 20 years. In addition, it remains to be seen if such ticking bombs can be safely incorporated in transport, etc. or to power emergency generators for the home and office. They also are still dependent on fuel. Nuclear power plants, again being strongly pursued, will require appreciable time (from 7 to 10 years) to get on line, at enormous expense, and they will further exacerbate the nuclear radiation hazards and multiply the unsolved nuclear wastes problem. Further, none of these centralized solutions does anything to unburden the already very inadequate grid and power distribution systems, which in the U.S. alone require another \$100 billion or so expenditure in the near future. In contrast, the invention lends itself to both large and small applications, and to either centralized or decentralized power distribution. Further, it can be developed and deployed with extraordinary rapidity, so that in two years a wide range of systems and sizes and output capabilities can be readied. Special adaptations—such as for converting large overload-assisting batteries in major power systems to become actual *self-sustaining generators*—can be developed rapidly to further boost the capability, survivability, and flexibility of the present power grid systems. Combined with eliminating the need for fuel, the fuel distribution and storage systems, refineries, etc., the invention dramatically reduces the overhead logistics burden of power systems in which the invention is incorporated. It is indeed capable of being the timely solution so desperately needed worldwide.



## Photo Section

**Editor's note:** All photos in this section are copyrighted properties from the archives of Energetic Productions, I.L.C.

The resolution of the images is sometimes limited by the resolution available from a selection of video "frame-grab" source files.

While the Energetic Productions camera crew was permitted to film the Bedini test and production lab in order to record interviews with John Bedini, information about the motors was not released to us. Nor are we permitted to present their specifications and capabilities. We did, however, while in consideration of publishing this book, feel it was extremely valuable to the reader to include these images.



John Bedini, CA, 1984

FREE ENERGY GENERATION

---



JOHN BEHN, CA. 1984



JOHN BEHN CA. 1984

FREE ENERGY GENERATION

---



JOHN AND TOM BLAROEN, CIRCA 2000



TOM BLAROEN AT BIDDEN LAB, OCTOBER 13, 2000 DURING TESTS RUN BY T.U.V. ENGINEERS FROM GERMANY



FREE ENERGY GENERATION



TOM BEARDEN AT BEOMI LAB, OCTOBER 13, 2000 DURING TESTS RUN BY T.U.V. ENGINEERS FROM GERMANY



TOM BEARDEN AT BEOMI LAB, OCTOBER 13, 2000 DURING TESTS RUN BY T.U.V. ENGINEERS FROM GERMANY

FREE ENERGY GENERATION

---



Tom Bearden at Bearden Lab, October 19, 2000 during tests run by T.U.V. Engineers from Germany



John Bearden, 2004

## FREE ENERGY GENERATION

---

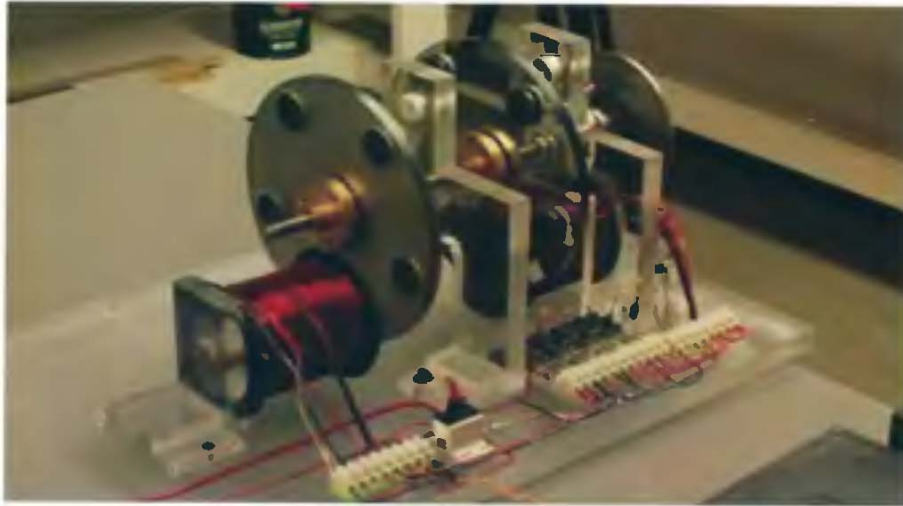

BECHI MOTOR PROTOTYPE



BECHI MOTOR PROTOTYPE 2004

FREE ENERGY GENERATION

---



BEEMH MOTOR PROTOTYPE 2004

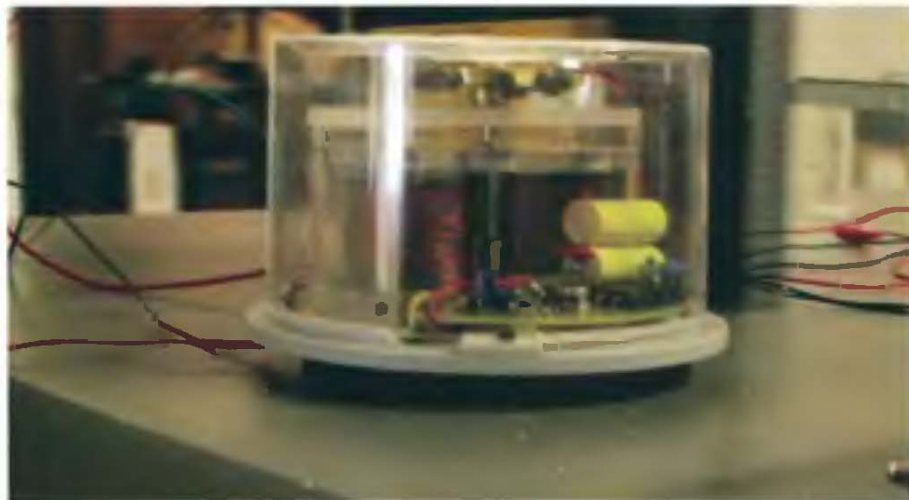

BEEMH MOTOR PROTOTYPE 2004

FREE ENERGY GENERATION

---

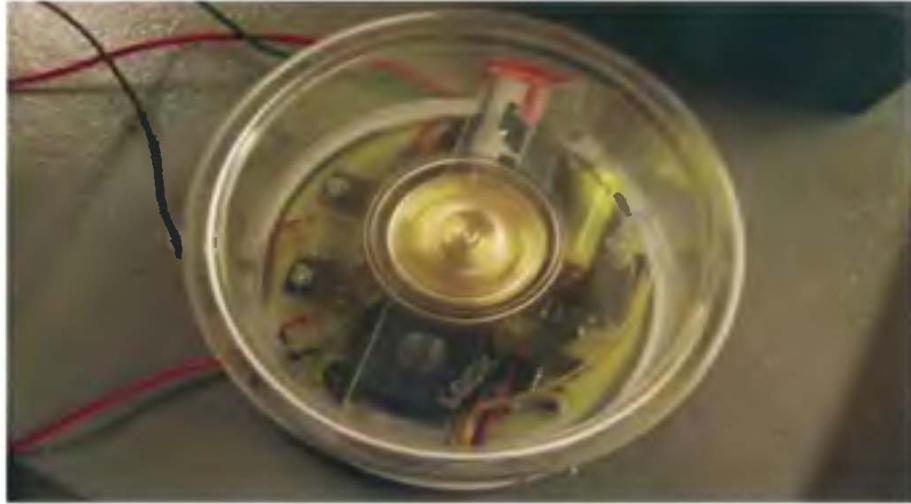

Bedini motor prototype 2004

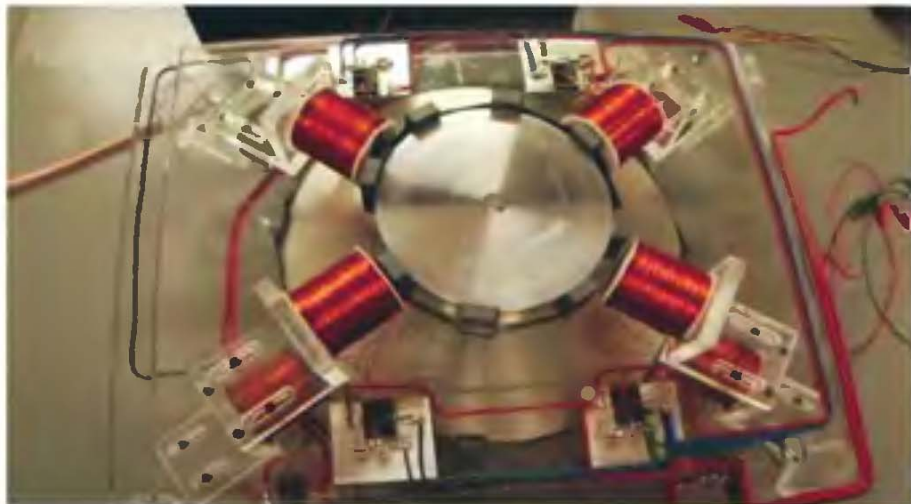

Bedini motor prototype 2004

## FREE ENERGY GENERATION

---

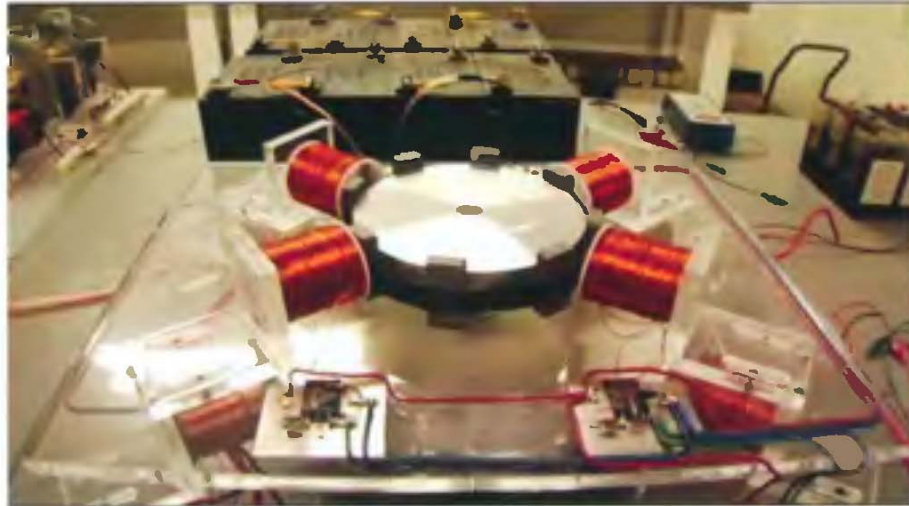

BLOWN MOTOR PROTOTYPE 2004

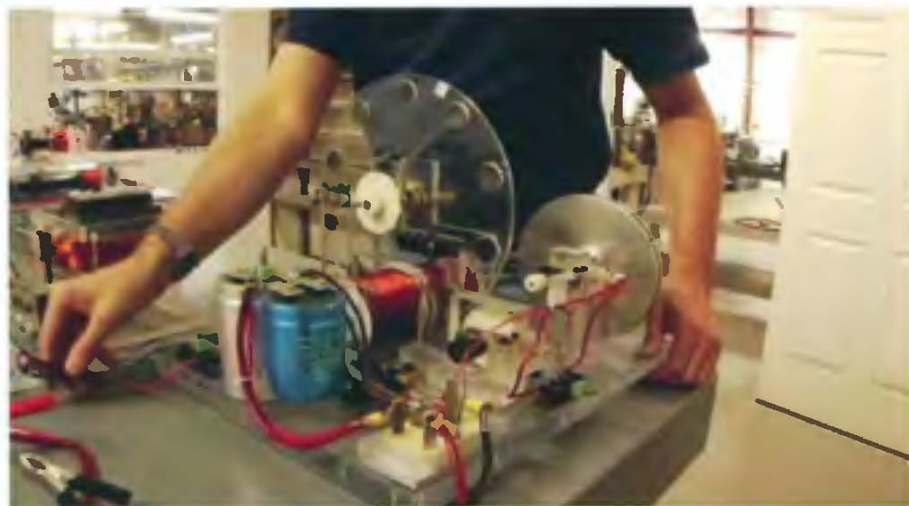

BLOWN MOTOR PROTOTYPE 2004

FREE ENERGY GENERATION

---

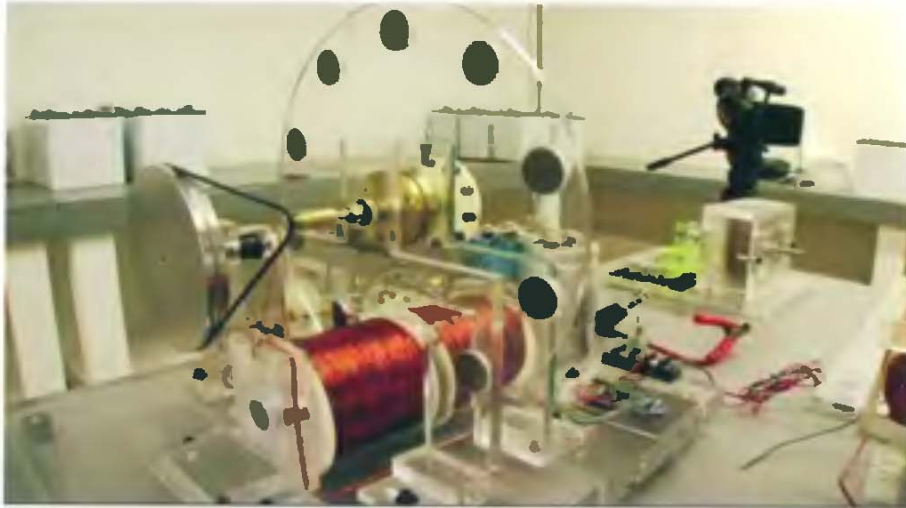

RED COIL MOTOR PROTOTYPE 2004

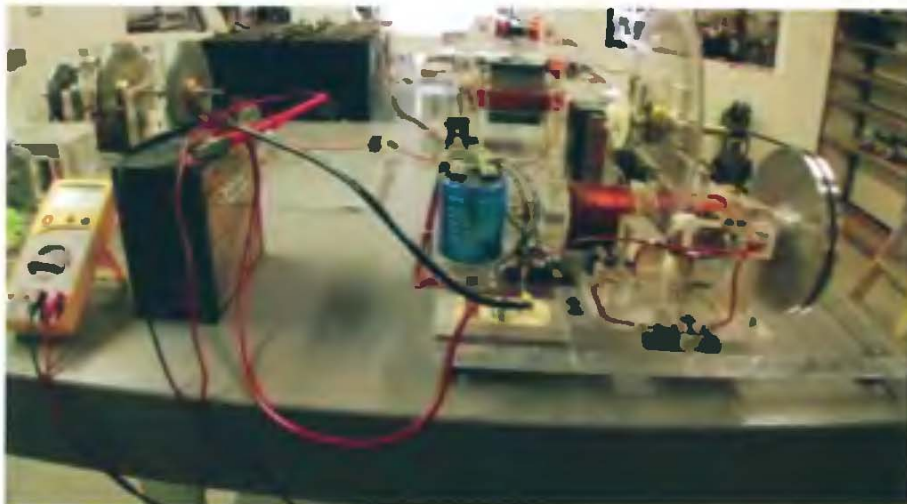

RED COIL MOTOR PROTOTYPE 2004

FREE ENERGY GENERATION

---

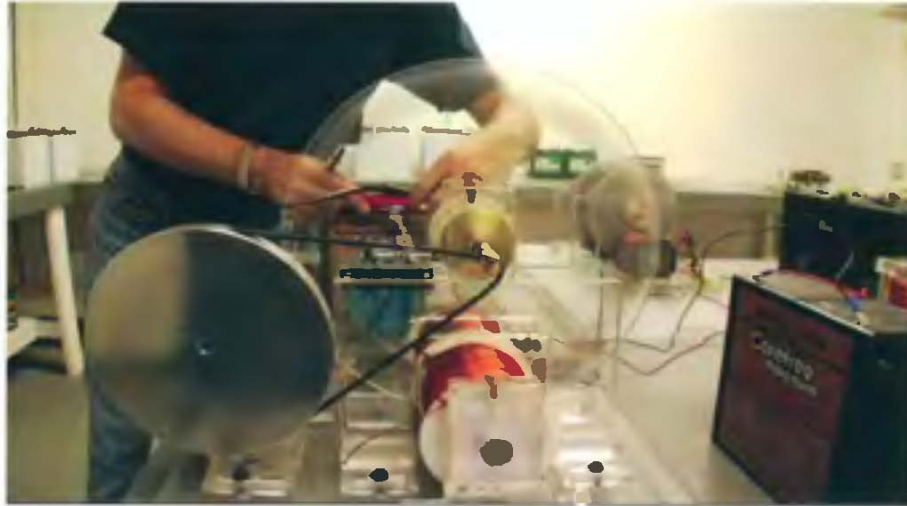

BLOWN MOTOR PROTOTYPE 2004

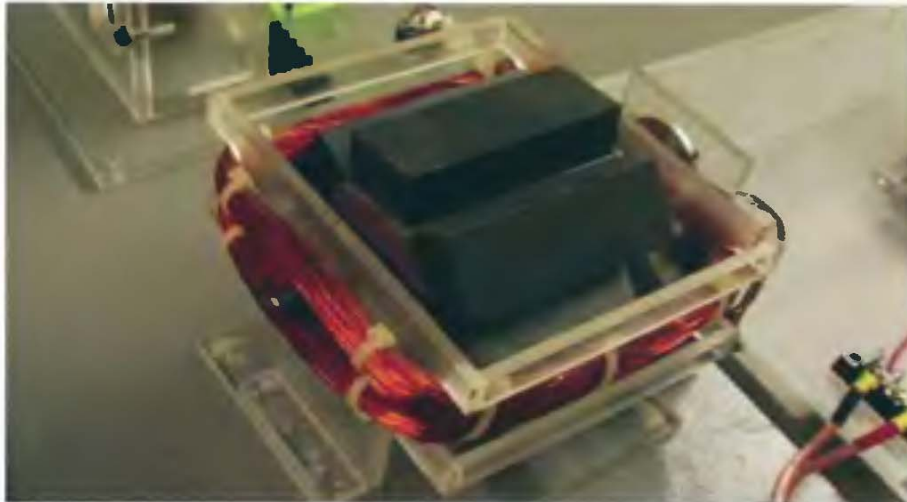

BLOWN MOTOR PROTOTYPE 2004



## FREE ENERGY GENERATION

---

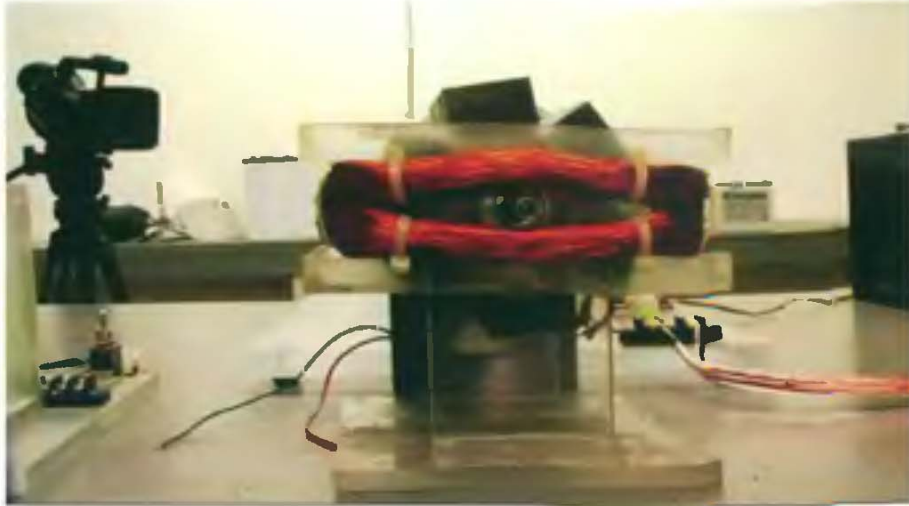

DC MOTOR PROTOTYPE 2004

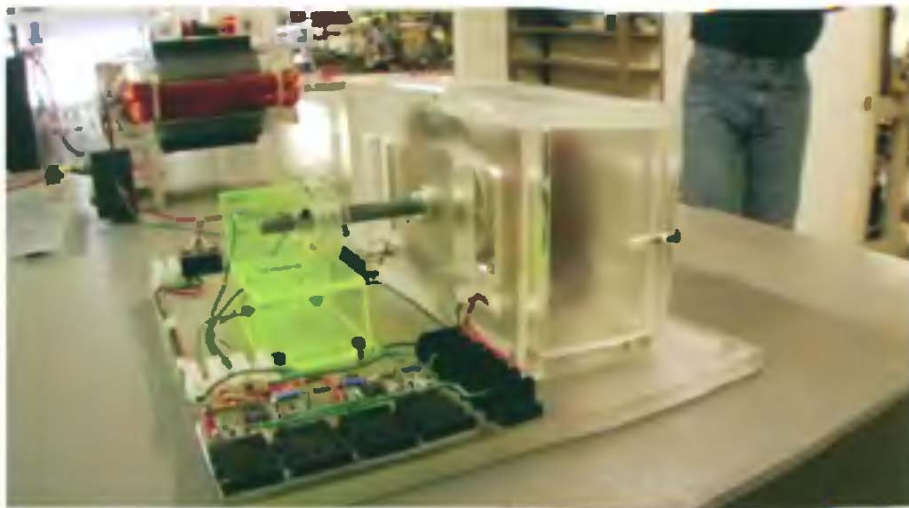

DC MOTOR PROTOTYPE 2004

FREE ENERGY GENERATION

---

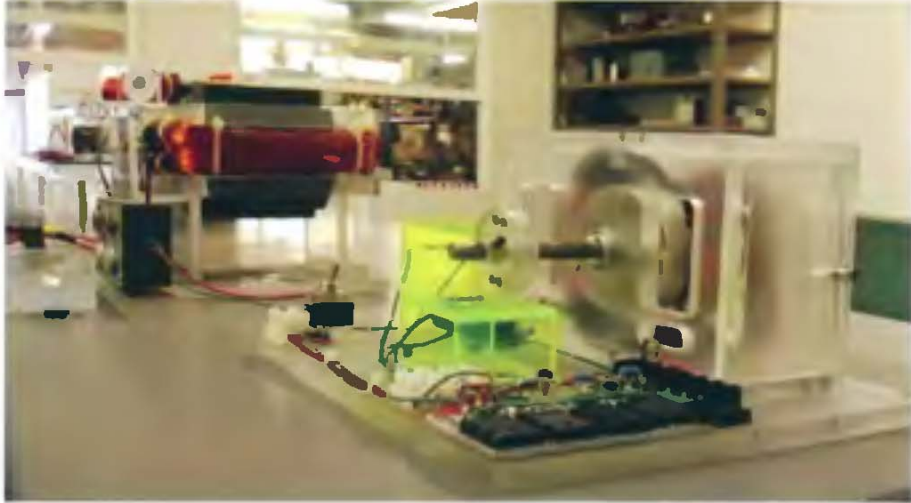

Blow Motor Prototype 2004

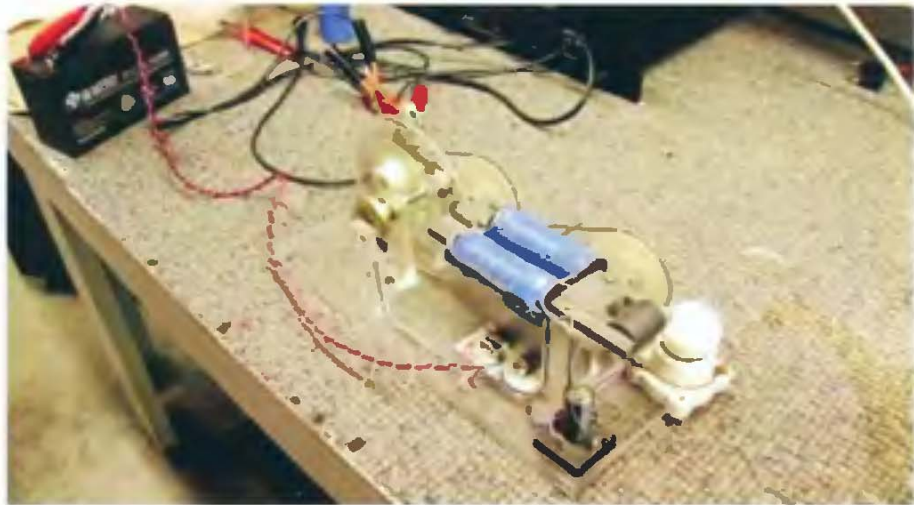

Blow Motor Prototype 2004

## FREE ENERGY GENERATION

---



BEDINI MOTOR PROTOTYPE RESULTS 2004

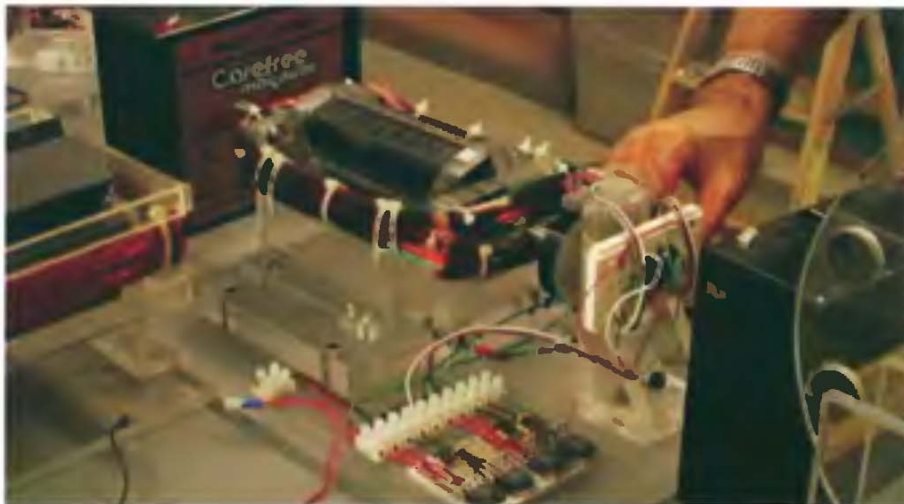

BEDINI MOTOR PROTOTYPE 2004



FREE ENERGY GENERATION

---



BEHINI SCROOXER, MOTOR 2004



BEHINI HENDERSHOT DEVICE REPLICATION 2004



## FREE ENERGY GENERATION

---



Brown waves 2005

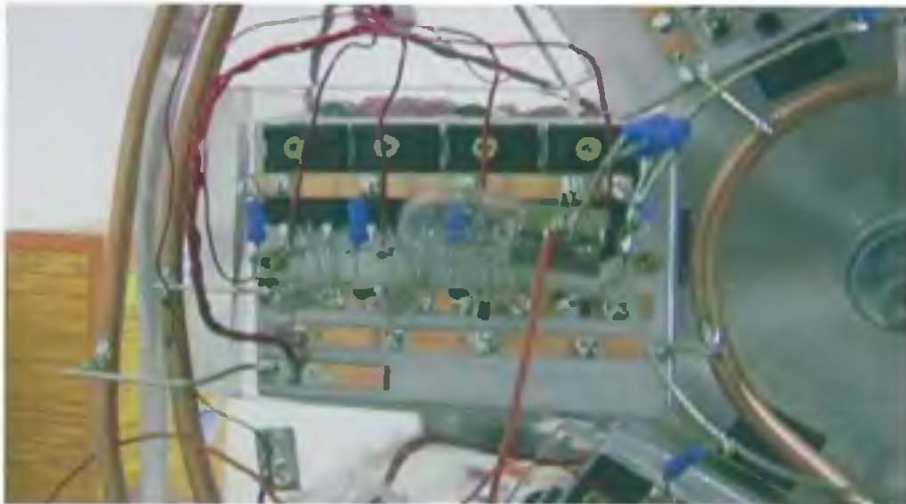

Bion Reactor prototype 2005

FREE ENERGY GENERATION

---



BEDINI MOTOR PROTOTYPE 2005



BEDINI MOTOR PROTOTYPE 2005



## FREE ENERGY GENERATION

---



BIDDI MOTOR PROTOTYPE 2005



BIDDI MOTOR PROTOTYPE OUTPUT 2005

## FREE ENERGY GENERATION

---



DEMONSTRATION AT BEHNI LAB WITH DAVE CLEMENTS, UK PHYSICIST; SEPTEMBER 2006

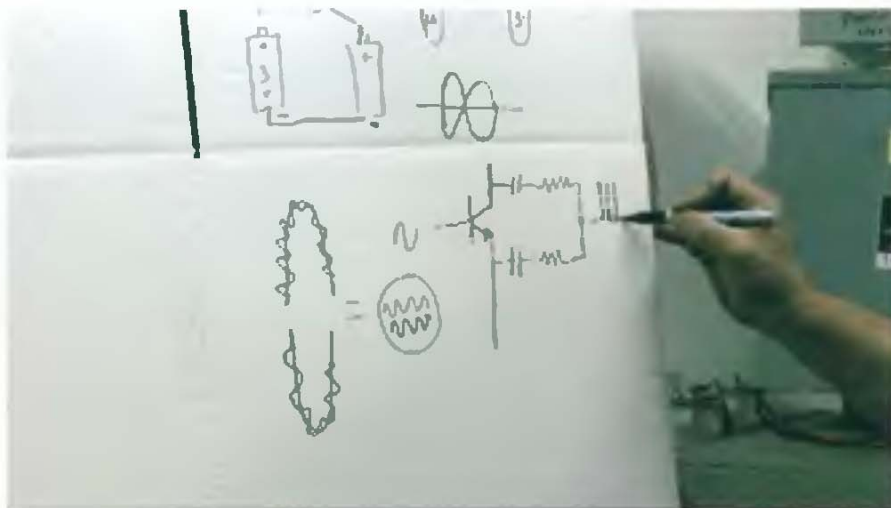

JOHN BEHNI SHOWS THE INFORMATION CONTENT OF THE TRIGGER PULSES; SEPTEMBER 2006

## FREE ENERGY GENERATION

---



JOHN BOHN EXPLAINS THE LOCATION OF THE SCALAR SOUTH POLE; SEPTEMBER 2006

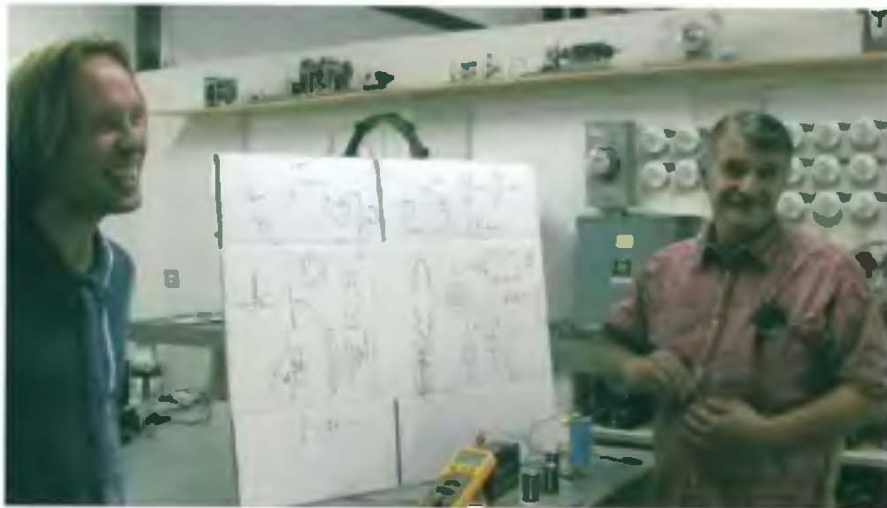

DEMONSTRATION AT BOHN LAB WITH DAVE CLEMENTS; SEPTEMBER 2006

FREE ENERGY GENERATION

---



JOHN BEIDEN SHORTS OUT A CAPACITOR CHARGED WITH RADIANT ENERGY. NOTE UNUSUAL COLOR OF THE FLASH; SEPTEMBER 2006



DEMONSTRATION AT BEIDEN LAB WITH DAVE CLEMENTS; SEPTEMBER 2006

NEW ENERGY

# The Attractions of Magnetism

Could a Little Child Be Leading Us to a Free Energy Future?

**T**he search for new energy technology takes us to northern Idaho to meet a ten-year-old girl who won a science fair with a battery-charging motor she describes as an advanced design that extends the life of batteries for an amazing length of time. The motor was designed by John Bedini and built by her. We meet him first.

More widely known as an audio-amplifier expert, Bedini's name is associated with "free energy" hoaxes. Whatever you think of his claims, it is certainly true that he and others were unable to build devices according to his published instructions. His curiosity was then focused severely at a conference in Boulder recently.

Aware of the new invention, with excited feelings I drove into the Idaho panhandle, past a warehouse for surplus auto supplies. My hope is that he will give clues so others can duplicate his successes.

Explaining his theory about such devices, new energy theorist Thomas Bedini is writing practically this year. Retired from electronic warfare studies and aerospace work, Bedini is the leading advocate of scalar potential electronics, and he explains how the use of energy, not heat, as an energy gets flux of virtual particles—could be engineered to do work in the physical world.

Bedini also has a theory about an effect of Bedini's "scalar" environment, one which can increase enjoyment of



Myranda Myranda Laughlin with her award-winning science project.



John Bedini working on a large, complex mechanical device.

music. After a six-year struggle, Bedini was granted U.S. Patent 5,687,057 for a mechanism for reducing electronic distortion in digital and analog recording and playback. Bedini (writing in *Esoteric Magazine*, Vol. 7, No. 4, pp. 63-65) says the patent examiner couldn't understand the mechanism, because Bedini's distinctive optics process was not found in audio, or classical electronics textbooks. Meanwhile, John and his brother Gary were already selling the ultra-direct recording devices. The process even works for media such as video film. Bedini explains Bedini's process is well

with no return paths for the magnetic electronics, and hopes that even structural metals can eventually be treated with it to reduce stress effects in the negative charge self-ordering in the physical world.

Bedini adds that most really new things are invented not by academic brains or corporate scientists but by the late "independent" American creative people.

I met Bedini at his business, surrounded by electronic equipment. The back room looks like a museum of small prototypes of unusual motor/generators. Some are put on a website (<http://www.magnetics.com>).

John is at <http://www.magnetics.com>.

He says his knowledge is on the extreme end and now it's up to others to build the devices. He says they have to experiment themselves, and it reminds me that he taught a little girl how to make a motor which drove a train. She had built a little motor made of plastic

The funny thing was that her father built a coat hanger and put a coil above the motor and used it as a generator. The motor ran much longer under the load than they had expected.

John Bedini was running the "free energy" scene in California in the 1970s and early 1980s, collecting knowledge about medical as well as energy devices. He had an electronics background in Mexico, and at home he experimented with windmills and other systems. The utility company objected—he was hooked up to their

Continued on Page 64

BY JEANE MANNING

32 ATLANTIC RISING • NUMBER 25

SUBSCRIBE OR ORDER BOOKS, VIDEOS AND MUSIC ONLINE

ATLANTIC RISING ARTICLE (TEXT FOLLOWS)

Text from *Atlantis rising* magazine (Number 25) article; (see detail)

## **The Attractions of Magnetism**

Could a Little Child Be Leading Us to a Free Energy Future?

By Jeane Manning

The search for new energy technology takes us to northern Idaho to meet a ten-year-old girl who won a science fair with a battery-charging motor. She describes it as an advanced design that extends the life of batteries for an amazing length of time. The motor was designed by John Bedini and built by her. We meet him first.

More widely known as an audio-amplifiers expert, Bedini's name is intertwined with "free energy" history. Witnesses saw his machines running successfully, but later others were unable to build devices according to his published instructions. His circuitry was mentioned favorably at a conference in Switzerland recently.

Aware of the controversies, with mixed feelings I drove into the Idaho panhandle, past a warehouse for survivalists' supplies. My hope is that he will give clues so others can duplicate his successes.

Explaining his theory about such devices, new-energy theorist Thomas Bearden is writing prolifically this year. Retired from electronic warfare studies and aerospace work, Bearden is the leading advocate of scalar potential electromagnetics, and he explains how the sea of energy we live in—an energetic flux of virtual particles—could be engineered to do work in the physical world.

Bearden also has a theory about another of Bedini's "scalar" inventions—one which can increase enjoyment of music. After a six-year struggle, Bedini was granted US Patent 5,487,054 for a mechanism for reducing electronic distortion in digital and analog recording and playback. Bearden (writing in *Explore Magazine* Vol. 7, No. 4, pp 53-63) says the patent examiner couldn't understand the mechanism, because Bedini's nonlinear optics process was not found in audio-, or classical electromagnetics textbooks. Meanwhile, John and his brother Gary were already selling the stress-defect-relieving devices. The process even works for media such as color film. Bearden explains Bedini's process as self-oscillating, optical-electronics, and hopes that even structural metals can eventually be treated with it to reduce stress defects. Is this negative entropy—self-ordering in the physical world?

Bearden adds that most really *new* things are invented not by academic teams or corporate scientists but by the lone "independent, fiercely creative people."

I meet Bedini at his business, surrounded by electronics equipment. The back room looks like a museum of small prototypes of unusual motor/generators. Some are picture on websites <http://rand.nidlink.com/John1> or <http://www.icehouse.net/john1/tesla.html>.

He says his knowledge is on the internet, and now it's up to others to build the devices. He says they have to experiment themselves, and it reminds me that he taught a little girl how to make a motor which drove science teachers nuts—to see a little motor made of plastic with no return paths for the magnetics.

“The funny thing was that her father bent a coat hanger and put a coil above the motor and used it as a generator. The motor ran much longer under the load than they had expected.”

John Bedini was roaming the “free energy” scene in California in the 1979s and early 1980s, collecting knowledge about medical as well as energy devices. He had an electronics business in Sylmar, and at home he experimented with windmills and other systems. The utility company objected—he was hooked up to their power lines and if his system were to backfeed, it could extinguish the lights in the neighborhood. He disagreed. As he tells it, the officials' final word was “we think you're stealing power” and they took their meter off the building. However, his lights were still on at night, because of his energy inventions, he tells me. Finally they struck a deal—he would have his power meter back but would pay a high fee for the service.

The power company almost took away their hookup to his shop, but it was in an industrial area and they would have had to remove a tree-phase transformer and therefore deprive the other businesses of power. “They found that when they switched off all the power in the shop nothing (electrical) was being drawn, but the machines kept running.”

He published instructions for an energy device which Jim Watson of Colorado Springs then built—large-scale with a heavy fly-wheel. Watson demonstrated it at the 1984 Bicentennial symposium celebrating Nikola Tesla's arrival in the USA.

At the same meeting, Bedini displayed a circuit which charges batteries. Only one engineer out of the audience—Eike Mueller of the European Space agency—got up and measure Bedini's apparatus. He affirmed that it was charging the batteries.

Dr. Hans Nieper's book *Revolution in Technology, Medicine and Society* states that Bedini's converter was 800% efficient in initial tests, and that 26 independent researchers successfully duplicated the device about which Bedini reported.

However, the staff of the no-longer-published magazine *Energy Unlimited* was unable to replicate the devices, and consulting engineer George Hathaway criticized Mueller's measurements.

On the other hand, a presenter at the 1985 USPA conference, Ken Moore, found that his model of Bedini's G-Field Generator increased speed as its load increased. He also witnessed a Bedini prototype successfully operating.

The same year, radio KABC talk show host Bill Jenkins used his guest speaker's spot at a March 12 Town Hall form at the Biltmore Hotel in Los Angeles to announce a free energy device, with Bedini and Steven Werth. The two demonstrated what was described as a Kromrey gravity-field generator with 180% efficiency, powered by a battery bank which required no recharging from an outside source.

A newspaper account said the audience included public utility representatives and investment brokers. Bedini, the 37, told the forum that he planned to make his generator universally available to the public at a nominal cost, instead of selling to the highest bidder. He described his working model as using stressed, pulsed scalar waves out of phase, to tap zero-point energy of the vacuum of space. The concept was not found in physics books, but is perfectly natural and it works, he said.

Jenkins had publicly introduced concepts such as scalar interferometry through one of his radio guest, physicist Bearden.

How did the civic officials at the Biltmore forum react to the "free energy" demonstration—light bulbs strung across their luncheon plates? Bedini recalls the growled demands to remove the d\_\_\_\_\_ bulbs so they could eat. "Free energy" was not a part of their reality.

Within a few weeks, Bedini was visited by two thugs who were definitely unfriendly toward his efforts to unhook from today's power structures. They had the appearance of body-builders who had just stepped out of a gymnasium, and pushed him against his shop wall while saying in a threatening manner that they expect he will continue to use gasoline. He laughs shortly while recalling the incident, but evidently knew they were serious.

Now that he has moved to Idaho, the reason "they" don't bother Bedini any more, he figures, is that he limits his models to toy-size. His model collection only demonstrates a principle—that he believes could power a house if scaled up in size. The principle involves storing discharged pulses of energy that are created while doing work with previously stored energy. The sequence is "do the work, discharge, so the work, discharge" and so on.

The devices operate in a manner contrary to conventional motors and generators, I am told. "You want the thing to do work. The more work it does, the more energy it gathers." Bedini says.

A recent model, incorporating a bicycle wheel with magnets glued on the inside of the perimeter, has a large-bladed fan—angled to slow the rotation—as the work load. Bedini unhooked part of his circuit to demonstrate the spark. He was showing how much energy is sent back to the battery, continually in step.



Repeatedly the setup runs the motor for a certain length of time, shuts it off and then discharges.

Bedini is scornful of experts who have visited him and can't understand why a small motor could be charging a battery yet the motor does not slow down.

"We understand what the energy is. Tesla knew exactly what it was. And it's the furthest thing from what they want to measure with their electron-pushers."

Today's instruments all measure electron flow, he said, but no meters are available to measure what is involved in his models. What, then, Bedini dealing with? It's electrostatic in nature, he replies, and must be converted into standard electricity.

The rhythmic pop, pop, pop sound of a Bedini device comes from a blue spark which he describes as an ultraviolet type of arc—similar to radio-frequencies but no RF. It can be accumulated and discharged in pulses which then can be converted into electrons.

If scientists want to build a big electron-pusher, the answers are on his website, he said. However, Bedini has no patience with researchers who ask for specifics such as where to buy the magnets. "Just go get them. Don't bother me." He said the devices only need to be tuned, and exact materials are not crucial. "Use the type of magnets that fit your wheel. If you don't get enough output from the coils, add more windings. Or change the geometry."

I'll visit the little girl and see if it is that easy.

Earlier this year Shawnee Baughman wanted a science fair project. She found a book with plans for a motor, but looked boring—corks and match boxes. Her father promised the parts for a better one. He works near John Bedini, who instructed Shawnee for a couple of hours a day for a few days. She finished building it the day before the fair.

"We only tested it for like a day, left it running overnight sometimes, but sometimes we'd leave it running for an hour or two hours or something."

The other kids liked it; that's how it was voted 'best of show.' Adult judges gave her the other top prizes.

She flicks the wheel into motion and it runs.

"This is the electromagnet coil. It what the power wire and the trigger wire ... The power wire carries the voltage around the electromagnet coil and it goes through to the transistor—that little black thing—then it goes through the resistor and the diode and the trigger wire follows it and then the voltage flow comes out again and returns back to the negative side of the battery. The electromagnet generates the power, then it spins the wheel; the electricity goes through the generator coil which lights up the light-emitting diode. Then it starts all over again."

“We’ve been using this battery for a month or so now. It’s supposed to have only 900 spins per nine volts, and that’s a nine-volt battery, so if it were to run out then would have run out a long time ago!”

She has changed the battery three times since building it six months ago.

Schools’ involvement in the new-energy field adds impetus. Andreas Manthey is an instructor who organized a Study Group for Free Energy at the Technical University of Berlin, Germany. He says the German Version of them impelled him back into new-energy research.

Jim Watson disappeared from the public new-energy scene a couple of years after the 1984 demonstration, but John Bedini and colleagues are sharing as much information as they believe that they can share. Bedini views children such as Shawnee as our hope for the future.

\* \* \*



## References

1. T. E. Bearden, Energy from the Vacuum: Concepts and Principles, Cheniere Press, Santa Barbara, CA, 2002, Chapter 3: Giant Negentropy, Dark Energy, Spiral Galaxies and Acceleration of the Expanding Universe. Available from [www.cheniere.org](http://www.cheniere.org).
2. Because of its abstract “esthetic mathematical beauty”, electrodynamicists mostly use *symmetrical* re-gauging, in which both the potentials  $\phi$  and  $A$  are freely changed in magnitude, but restricted to only the cases where the two free force fields that result are equal and opposite. In symmetrical re-gauging, additional free potential energy and the two new free force fields obtained by the re-gauging are “bottled up” in the system as a change in the system's stress energy. Thus it is deliberately rendered incapable of forcibly translating electrons through loads since the net resultant force is a zero vector. Work is given by  $W = \int \mathbf{F} \bullet d\mathbf{s}$ , and if there is no net free  $\mathbf{F}$  there can be no net free  $W$ .

*Asymmetrical* re-gauging is merely changing only one potential (e.g.,  $\phi$  or  $V$ ) so that a net free force field  $\mathbf{F}$  does result and can be used to provide free emf in the system to do work and power loads by  $W = \int \mathbf{F} \bullet d\mathbf{s}$ . So to get their electrical power circuits to do any work at all, scientists have to asymmetrically regauge anyway (usually by changing the voltage, which of itself is work-free if no current is moved in the process). *Within physical materials limitations, as much additional potential energy as one wishes can be freely added to any electrical circuit by merely increasing its voltage appropriately, if current is not allowed to move or appreciably move during the asymmetrical re-gauging.* Voltage amplification alone is not power and does no work. However, the closed current loop circuit forcibly requires a further *symmetrical* re-gauging once the current flows, and the closed current loop circuit thus “kills its own input flow of extra energy” faster than that extra, free potential energy can be used to power the loads. Why this incredible *self-limitation to COP < 1.0* of the standard closed current loop circuit has continued to be used by our electrical power scientists and electrical power engineers for more than a century is absolutely inexplicable.

3. For a discussion of the supersystem and some of the novel effects of the mutual interaction of its three components, see T. E. Bearden, Energy from the Vacuum: Concepts and Principles, *ibid.*, 2002, Chap. 9. The book is available from [www.cheniere.org](http://www.cheniere.org).
4. Paul Davies, Superforce: The Search for a Grand Unified Theory of Nature, Simon and Schuster, New York, 1984, p. 105.
5. M. W. Evans, “The Link Between the Sachs and O(3) Theories of Electrodynamics,” in Modern Nonlinear Optics, Second Edition (3 vols.), Edited by Myron W. Evans; article is in Vol. 2, 2000, p. 469-499. The 3 volumes comprise Vol. 119 of Advances in Chemical Physics, Wiley, New York, Ilya Prigogine and Stuart A. Rice, Eds.

6. (a) T. D. Lee, "Is the Physical Vacuum a Medium?" Transactions of the New York Academy of Sciences, Series II, Vol. 40, Sep. 15, 1980, p. 111-123; (b) — Particle Physics and Introduction to Field Theory, Harwood, New York, 1981, "Chapter 25: Outlook: Possibility of Vacuum Engineering," p. 824-828.
7. Myron W. Evans, "The Equations of Grand Unified Field Theory in Terms of the Maurer Cartan Structure Relations of Differential Geometry," Foundations of Physics Letters, 17(1), Feb. 2004, p. 25-37.
8. Richard P. Feynman, Robert B. Leighton, and Matthew Sands, The Feynman Lectures on Physics, Addison-Wesley, Reading, MA, Vol. 1, 1964, p. 12-2.
9. E.g., see Steven Weinberg, Dreams of a Final Theory, Vintage Books, Random House, 1993, p. 111-112. As is well-known in particle physics and quantum field theory, a charge polarizes the surrounding vacuum. A single charge is actually comprised of an infinite bare charge in the center, surrounded in space by an infinite clustering of virtual charges of opposite sign. So both charges are infinite, although our instruments—peering through the Faraday screen of clustering opposite virtual charges—observe a finite difference with the sign of the inner bare charge—and that observed difference is the common classical textbook value of the "isolated charge". However, there are ongoing infinite energy processes involved. So infinite energy can be drawn from the seething activity of a single charge interacting with its environment. That energy can be collected in separate circuits, and thus used to power loads. The problem of the source charge—which continuously pours out observable photons with no observable energy input—was solved in 1999 and published in 2000 and again in 2002 by one of the present inventors (Bearden) {36}. The charge takes its input energy from the vacuum, coherently integrates the virtual mass changes of the charge due to the virtual photon changes absorbed, and re-emits the now-integrated energy as real, observable photons (the decay of the integrating state is triggered by the zitterbewegung of the vacuum the instant that the integrating virtual mass is sufficient to produce the  $\Delta E$  energy sufficient for an observable photon  $(\Delta E)(\Delta t)$ ). Every charge is already continuously producing negative entropy in the observable state by continuously consuming positive entropy in the virtual state activity in which it is embedded.
10. The charge is the first known example of a physical system actually producing continuous negative entropy, as theoretically shown by D. J. Evans and Lamberto Rondoni, "Comments on the Entropy of Nonequilibrium Steady States," J. Stat. Phys., 109(3-4), Nov. 2002, p. 895-920. Their theoretical demonstration so startled Evans and Rondoni that the authors themselves doubted that any physical system could exhibit such a Gibbs entropy. To the contrary, the charge already does it, and it makes possible *macroscopic systems* which also do it. In short, the present invention is but the beginning of a new age of negentropic engineering, as contrasted to the present entropic engineering that has so polluted and damaged the Earth and its environment.
11. Feynman, *ibid.*
12. J. D. Jackson, Classical Electrodynamics, 2nd Edn., John Wiley & Sons, New York, 1975, p. 249.

13. Feynman, *ibid.*, vol. II, 1964, p. 1-3.
14. (a) E. T. Whittaker, "On the Partial Differential Equations of Mathematical Physics," Math. Ann., Vol. 57, 1903, p. 333-355; (b) — "On an Expression of the Electromagnetic Field Due to Electrons by Means of Two Scalar Potential Functions," Proc. Lond. Math. Soc., Series 2, Vol. 1, 1904, p. 367-372. The latter paper was published in 1904 and orally delivered in 1903. Note: in the latter paper, on p. 368 mid page, Whittaker's equation for the y-component of vector-potential "a" is missing the exponent "2" on the del operator.
15. We strongly stress that "work" involves energy that has escaped the system's ability to utilize in that form. Work rigorously is the change of form of energy, not the change of magnitude of energy (a correction to the present first law of thermodynamics is required, since presently it erroneously equates change of magnitude of the energy of system external parameters (such as potential  $\phi$ ) as work a priori. It is not necessarily work; if the excess energy is input in the same potential form, it is simply free asymmetrical re-gauging and no work is done. If the energy is input in some other form (such as the mechanical shaft energy input to the generator), then the form of the energy has been changed and that is work. As presently written, the first law of thermodynamics erroneously excludes gauge freedom, which—if true—would falsify much of modern physics.
16. D. J. Evans and Lamberto Rondoni, "Comments on the Entropy of Nonequilibrium Steady States," J. Stat. Phys., 109(3-4), Nov. 2002, p. 895-920.
17. T. D. Lee, Particle Physics and Introduction to Field Theory, Harwood, New York, 1981, "Chapter 25: Outlook: Possibility of Vacuum Engineering," p. 824-828.
18. Trivially we point out that  $q$  (called "charge") is actually *charged mass*, and any charge consists of a mass system engaged in interactions with the other two components of its supersystem (i.e., with curved spacetime dynamics and with the dynamics of the local vacuum flux). The word "charge" actually should more properly apply to that ongoing interaction. In turn, this answers Silverman's problem that "... *curiously enough, we do not know exactly what charge is, only what it does. Or, equally significantly, what it does not do.*" Quoted from M. P. Silverman, And Yet It Moves: Strange Systems and Subtle Questions in Physics, Cambridge University Press, Cambridge, 1993, p. 127. Now we know what it is or should be regarded as, and we know additional things that it does.
19. Feynman, *ibid.*, Vol. 1, 1964, p. 4-2.
20. Symmetrical freedom (symmetrical re-gauging) is normally used by the theorists, since it may change the stress of the system (it produces two free opposite and equal forces), but does not produce any free *net translation* force. Precisely chosen asymmetrical changes (of two potentials) are utilized, so that this condition is fulfilled. However, there is no law of nature requiring that these two potentials be changed symmetrically, or even that both be changed! Each can be asymmetrically changed at will also, in which case a net free translation force does result. That free translation force and the excess energy accompanying it can then be used to produce free work. As a trivial example, when we wish to enable an electrical system to perform work, we change its potential  $V$  asymmetrically. Unfortunately we also have been

trained to employ the closed current loop, well grounded, which self-enforces symmetrical re-gauging by destroying the dipolar source of the potential  $V$  as fast as it powers the loads and losses. Hence we have to keep paying to furnish more  $V$  to continue to re-establish the dipolarity. In short, we pay the power company to engage in a giant Sumo wrestling match inside its generators—and *lose*.

21. Paul Davies, Superforce, *ibid.*, 1984, p. 115.
22. It is believed that Nikola Tesla was approaching energy flow in a similar manner, and he certainly used a longitudinal EM wave model similar to what Whittaker had shown. E.g., see (a) Nikola Tesla, "Pioneer Radio Engineer Gives Views on Power," New York Herald Tribune, Sep. 11, 1932. Quoting: "...I showed that the universal medium is a gaseous body in which only longitudinal pulses can be propagated, involving alternating compressions and expansions similar to those produced by sound waves in the air. Thus, a wireless transmitter does not emit Hertz waves which are a myth, but sound waves in the ether, behaving in every respect like those in the air, except that, owing to the great elastic force and extremely small density of the medium, their speed is that of light." By whatever methods he used, Tesla was also able to move potential and its positive energy around in a circuit in a manner invisible to standard vector or tensor analysis. It could be seen, however, by an analysis using higher group symmetry electrodynamics. E.g., see (b) T. W. Barrett, "Tesla's Nonlinear Oscillator-Shuttle-Circuit (OSC) Theory," Annales de la Fondation Louis de Broglie, 16(1), 1991, p. 23-41. Barrett went on to extend Tesla's positive energy shuttling process in two patents, being (c) T. W. Barrett, "Oscillator-Shuttle-Circuit (OSC) Networks for Conditioning Energy in Higher-Order Symmetry Algebraic Topological Forms and RF Phase Conjugation," U.S. Patent No. 5,493,691, Feb. 20, 1996 and (d) T. W. Barrett, "Active Signalling Systems," U.S. Patent No. 5,486,833, Jan. 23, 1996.
23. For detailed development of this fact, see T. E. Bearden, Energy from the Vacuum: Concepts and Principles, Cheniere Press, Santa Barbara, CA, 2002, available from [www.cheniere.org](http://www.cheniere.org).
24. For the thermodynamics of the Carnot heat pump, see (a) William C. Reynolds, Thermodynamics, 2nd Edition, McGraw-Hill, New York, 1968, p. 250-252. See also (b) David Halliday and Robert Resnick, Fundamentals of Physics, Third Edition Extended, Wiley, New York, 1988, Chapter 22. See particularly Vol. 1, p. 518, Sample Problem 5. The variable *theoretical maximum* COP of a standard heat pump, operating as a refrigerator to cool the great outdoors under nominal conditions, may be 9.22.
25. E.g., it is not commonly recognized that a standard hydroelectric power system together with its complete grid being powered, constitutes a  $COP = \infty$  thermodynamic system when the river's flow is accounted. All the primary energy is input by the external environment, with none being input by the operator. Of course the hydroelectric system is an incredibly bad system, considered from the radiant energy engineering standpoint. At every point where it applies electrical engineering, it automatically includes the closed current loop circuit to guarantee killing the fundamental source dipolarities. Again, the power company engages in a giant wrestling match inside its generators and *loses*.

26. T. E. Bearden, "Leyton's Hierarchies of Symmetry: Solution to the Major Asymmetry Problem of Thermodynamics," Explore, 12(6), 2003, p. 59-61. Also on [www.chenierye.org](http://www.chenierye.org).
27. D. K. Sen, Fields and/or Particles, Academic Press, London and New York, 1968, p. viii.
28. Mario Bunge, Foundations of Physics, Springer-Verlag, New York, 1967, p. 173.
29. *Ibid.*, p. 176.
30. B. P. Kosyakov, "Radiation in electrodynamics and in Yang-Mills theory," Sov. Phys. Usp. 35(2), Feb. 1992, p. 135, 141.
31. Steven Weinberg, Dreams of a Final Theory, Vintage Books, Random House, 1993, p. 109-110.
32. Lee and Yang strongly predicted broken symmetry in 1956-57; see (a) T. D. Lee, "Question of Parity Conservation in Weak Interactions," Phys. Rev., 104(1), Oct. 1, 1956, p. 254-259; (b) T. D. Lee, Reinhard Oehme, and C. N. Yang, "Remarks on Possible Noninvariance under Time Reversal and Charge Conjugation," Phys. Rev., 106(2), 1957, p. 340-345.
33. So revolutionary was the prediction of broken symmetry that experimental physicists leaped to validate or falsify it. In early 1957 Wu and her colleagues experimentally proved broken symmetry, including that of opposite charges. See C. S. Wu, E. Ambler, R. W. Hayward, D. D. Hoppes and R. P. Hudson, "Experimental Test of Parity Conservation in Beta Decay," Phys. Rev., Vol. 105, 1957, p. 1413.
34. With unprecedented speed, the Nobel Committee awarded the Nobel Prize to Lee and Yang in the same year, in Dec. 1957, for their astounding and revolutionary prediction.
35. Tom Van Flandern, "The speed of gravity – What the experiments say," Phys. Lett. A, Vol. 250, Dec. 21, 1998, p. 8-9.
36. (a) T. E. Bearden, "Giant Negentropy from the Common Dipole," J. New Energy, 5(1), Summer 2000, p. 11-23; (b) T. E. Bearden, Energy from the Vacuum, *ibid.*, 2002, Chapter 3; (c) M. W. Evans, T. E. Bearden, and A. Labounsky, "The Most General Form of the Vector Potential in Electrodynamics," Found. Phys. Lett., 15(3), June 2002, p. 245-261; (d) T. E. Bearden, Fact Sheet: "The Source Charge Problem: Its Solution and Implications," Aug. 28, 2003, updated October 30, 2003, carried on [www.chenierye.org](http://www.chenierye.org).
37. The original meaning of the term "entropy" was merely *dissipated potential energy*. Energy, when dissipated, is still there but in another form. In modern terms, *positive entropy* is merely a measure of some unavailable energy. *Negative entropy* would be merely a measure of some previously unavailable energy made newly available by some recovery process. Negative entropy does not violate the conservation of energy law, but merely "recovers" some previously unusable energy; the energy is still conserved. In short, negative entropy simply implies the change of form of some unavailable energy so that it then becomes available for use.



Negative entropy therefore involves a process that consumes positive entropy as its input, and outputs usable, controlled energy, thereby exhibiting what is often called "negative work." A negative entropy process has more usable energy resulting from the output of the process than the usable (to the referent system) energy that was input by the operator, because it also recovered some available but previously unusable energy. The excess output energy is input to the process in entropic (disordered) form. Conservation of energy is rigorously obeyed by any and every negative entropy producing process, by the process consuming entropy.

There is nothing "mystical" in either the term *positive entropy* or the term *negative entropy*, contrary to the prevailing mystique that has been built up around these terms for a century. Each may be transduced into the form of the other.

Because of the mystique, the notion of *absoluteness* has been improperly assigned to the present second law of thermodynamics and its exclusion of all negative entropy processes. Some negative entropy processes are in fact already known to occur and are recognized by thermodynamicists, both theoretically and experimentally, in violation of the present overly restrictive second law of thermodynamics.

E.g., see (a) D. J. Evans and D. J. Searles, "Equilibrium microstates which generate second law violating steady states," *Phys. Rev. E*, Vol. 50, 1994, p. 1645-1648; (b) D. J. Searles and Denis J. Evans, "The fluctuation theorem for stochastic systems," *Phys. Rev. E*, vol. 60, 1999, p. 159-164; (c) — "The fluctuation theorem and Green-Kubo relations," *J. Chem. Phys.*, Vol. 112, 2000, p. 9727-9735; (d) — "Ensemble dependence of the transient fluctuation theorem," *J. Chem. Phys.*, Vol. 113, 2000, p. 3503-3509; (e) D. J. Evans, E. G. D. Cohen, and G. P. Morriss, "Probability of second law violations in Nonequilibrium steady states," *Phys. Rev. Lett.*, Vol. 71, 1993, p. 2401-2404; "Erratum", *ibid.*, Vol. 71, 1993, p. 3616. Also particularly see (f) G. M. Wang, E. M. Sevick, Emil Mittag, Debra J. Searles, and Denis J. Evans, "Experimental Demonstration of Violations of the Second Law of Thermodynamics for Small Systems and Short Time Scales," *Phys. Rev. Lett.*, 89(5), 29 July 2002, 050601.

Also particularly see (g) the statement by Dilip Kondepudi and Ilya Prigogine, *Modern Thermodynamics: From Heat Engines to Dissipative Structures*, Wiley, Chichester, 1998, reprinted 1999 with corrections, p. 459 where the authors point out that *strong gradients* are a known area violating the second law of thermodynamics, and that not much is known about it, either theoretically or experimentally. We point out, however, that thermodynamicists have not heretofore recognized that *negative energy* input back to the system from the local vacuum is the *reason* for violation of the second law in that strong gradient. It therefore does come as a surprise to thermodynamicists that strong gradients and very sharp pulsing can be used to obtain negentropy and to perform negentropic charging of batteries and capacitors, and powering of circuits and systems.

Finally, the production of work dissipates energy by changing its form (usually to an unusable new form or to an inaccessible location) and thereby produces entropy. However, the "unavailable energy" that was dissipated also still remains as energy. Not one joule of energy is "lost" from the universe by producing work. It is only "lost" with respect to control by the losing system which no longer can control and

use that energy in its new form or location after the work or dissipation has been accomplished.

Accordingly, a negentropic (self-ordering) process can then be applied to the remaining usually unavailable energy (entropic energy) after the work has been done, to again reorder and recover the entropic energy as usable energy (changing its form yet again, so that it is usable again by the system). The newly available “recycled” energy can then be dissipated and used to perform work by the system all over again, and the law of conservation of energy is never violated by these processes.

In the presence of both entropic and negentropic processes in a system, work may be done to provide the unusable energy involved in positive entropy. This entropic energy can then be processed—“consumed” is the term used by thermodynamicists—by the negative entropy process as its “input” energy, and the entropic energy input can be reordered and changed in form so that it is output as *recovered and available* energy, so that it can again be used to perform further work.

There is no *conservation of work* law in nature; instead, there is only a *conservation of energy* law. Any linear “conservation of work and energy” law *a priori* arbitrarily assumes that no negative entropy operation is present to perform recovery and recycling of entropic energy when the work is done. In short, work is inappropriately used as a synonym for “permanently unrecoverable energy—at least unrecoverable by the system”.

The present second law with its erroneous exclusion of negative entropy processes has led to the great and recognized asymmetry problem of thermodynamics, which Price states as follows {38}:

“A century or so ago, Ludwig Boltzmann and other physicists attempted to explain the temporal asymmetry of the second law of thermodynamics. ... the hard-won lesson of that endeavor—a lesson still commonly misunderstood—was that the real puzzle of thermodynamics is not why entropy increases with time, but why it was ever so low in the first place.”

We have previously pointed out the solution to that long vexing problem {39}, based on Leyton's revolutionary work {40}.

Indeed, reordering processes and self-ordering processes are already known to be permissible in nonequilibrium steady state systems (such as is the source charge). For example; e.g. see (h) G. Nicolis and I. Prigogine, Self-Organization in Nonequilibrium Systems: From Dissipative Structures to Order through Fluctuations, Wiley, New York, 1977; (i) D. Kondepudi and I. Prigogine, “Thermodynamics, Nonequilibrium,” Encyclopedia of Applied Physics, Vol. 21, 1997, p. 311-337. The Nobel Prize was awarded to Ilya Prigogine for his contributions to the theory and knowledge of such systems far from equilibrium.

38. Huw Price, Time's Arrow and Archimedes' Point, Oxford University Press, 1996, paperback 1997, p. 78.
39. T. E. Bearden, Fact Sheet: “Leyton's Hierarchies of Symmetry,” 2003, *ibid*.
40. (a) Michael Leyton, A Generative Theory of Shape, Springer-Verlag, Berlin, 2001. Leyton extends Klein's 1872 geometry and group theoretic methods, yielding a hier-

archy of symmetries. In Klein geometry, when symmetry is broken at one level, the symmetry information is lost at that level and the overall symmetry of the system is reduced. In Leyton's more advanced geometry, when symmetry is broken at one level, the symmetry information is retained at that level and a new symmetry is generated at the next higher level. Hence Leyton's geometry permits and includes negative entropy processes. (b) The source charge furnishes a concrete experimental example; see T. E. Bearden, Fact Sheet: "The Source Charge Problem: Its Solution and Implications," Aug. 28, 2003, updated Oct. 30, 2003, carried on [www.cheniere.org](http://www.cheniere.org). Also see (c) M. W. Evans, T. E. Bearden, and A. Labounsky, "The Most General Form of the Vector Potential in Electrodynamics," Found. Phys. Lett., 15(3), June 2002, p. 245-261; (d) T. E. Bearden, "Extracting and Using Electromagnetic Energy from the Active Vacuum," in M. W. Evans (ed.), Modern Nonlinear Optics, Second Edition, 3 vols., Wiley, 2001, Vol. 2, p. 639-698. The three vols. comprise a Special Topic issue as Vol. 119, I. Prigogine and S. A. Rice (series eds.), Advances in Chemical Physics, Wiley, ongoing.

41. (a) T. E. Bearden, "Fact Sheet: "Leyton's Hierarchies of Symmetry: Solution to the Major Asymmetry Problem of Thermodynamics," Explore, 12(6), 2003, p. 59-61. Also on <http://www.cheniere.org>. Also see (b) T. E. Bearden, "Source Charge, Van Flandern Waterfall, and Leyton Geometry," J. New Energy, 2004, (in press).
42. As stated, strong gradients are an area already known and recognized to violate the second law of thermodynamics, and not much is known about them, either theoretically or experimentally. For confirmation, see Dilip Kondepudi and Ilya Prigogine, Modern Thermodynamics: From Heat Engines to Dissipative Structures, Wiley, Revised and Corrected, 1999, p. 459.
43. Bedini's 30 years of research in rapid and anomalous recharging of storage batteries, by using sharp pulses, is therefore pioneering in scope. The present patent application further extends his previous work into new areas. His earlier work is partially described in T. E. Bearden, "Bedini's Method For Forming Negative Resistors In Batteries," Proc. Congress 2000, St. Petersburg, Russia, Vol. 1, July 2000, p. 24-38; also published in J. New Energy, 5(1), Summer 2000, p. 24-38. The paper is also carried on restricted DoE website [www.ott.doe.gov/electromagnetic/](http://www.ott.doe.gov/electromagnetic/) and on [www.cheniere.org](http://www.cheniere.org).
44. Partial description of the Bedini battery charging and powering process is given in John C. Bedini, "Device and Method for Pulse Charging a Battery and for Driving other Devices with a Pulse," U. S. Patent Application #2003/0117111 A1, June 26, 2003. The present patent application describes additional *negative energy* processes not in 2003/0117111.
45. (a) See P. A. M. Dirac, "The quantum theory of the electron," Proc. Roy. Soc. London, Series A, 117(777), Jan. 2, 1928, p. 610-624; (b) — "The quantum theory of the electron, Part II," Proc. Roy. Soc. London, Series A, 118(779), Mar. 1, 1928, p. 351-361. See particularly (c) "A theory of electrons and protons," Proc. Roy. Soc. London, Series A, 126(801), Jan. 1, 1930, p. 360-365. In this latter paper, Dirac introduced the vacuum energy: The electron sea filled with electrons occupying negative energy states. The holes are treated as the positive electrons. This concept is now referred to as the "Dirac Sea." He attempted to identify a hole with a proton, but it was later recognized that the hole is a negative energy electron, which when

interacting with matter absorbs a negative charge and leaves an excess positive charge. We strongly stress that a Dirac sea hole is not a positron until it has interacted with matter (been observed). As it exists in the vacuum prior to observation, the Dirac hole is a negative energy source charge, producing negative energy EM fields and potentials. The positron, of course, is a positive energy electron with positive charge, producing positive energy EM fields and potentials.

46. James Clerk Maxwell, "A Dynamical Theory of the Electromagnetic Field," Roy. Soc. Trans., Vol. CLV, 1865, p 459. Read Dec. 8, 1864. Also in The Scientific Papers of James Clerk Maxwell, 2 vols. bound as one, edited by W. D. Niven, Dover, New York, 1952, Vol. 1, p. 526-597. The 20 equations and 20 unknowns are specifically given in this paper.
47. James Clerk Maxwell, "On a Method of Making a Direct Comparison of Electrostatic with Electromagnetic Force; with a Note on the Electromagnetic Theory of Light," Phil. Mag., Vol. CLVIII, 1868. Also in The Scientific Papers of James Clerk Maxwell, 2 vols. bound as one, edited by W. D. Niven, Dover, New York, 1952, Vol. 2, p. 125-143.
48. James Clerk Maxwell, A Treatise on Electricity and Magnetism, Oxford University Press, Oxford, 1873.
49. William Rowan Hamilton, Lectures on Quaternions, 1853; — Elements of Quaternions, 1866.
50. James Clerk Maxwell, Elementary Treatise on Electricity, 1881.
51. James Clerk Maxwell, A Treatise on Electricity and Magnetism, Second Edition, 1881. Foreword to the second edition was by Niven, who finished the work. Maxwell had dramatically rewritten the first nine chapters, with much new matter added, and with the former contents rearranged and much simplified. In his second edition, Maxwell had gone to some pains to reduce the quaternion expressions himself, and not require the students to know the calculus of quaternions (so stated on p. 257). Maxwell died before finishing the rest of the second edition. The remainder of the second edition is therefore largely a reprint from the first edition.
52. James Clerk Maxwell, A Treatise on Electricity and Magnetism, Third Edition, Oxford University Press, 1892. Also available as the Third Edition, Volumes 1 and 2, Unabridged, Dover Publications, New York, 1954. This edition was edited by J. J. Thomson, who also wrote a "Supplementary Volume" containing his notes.
53. (a) Heaviside's work was eventually published as Oliver Heaviside, Electromagnetic Theory, 3 vols., Benn, London, 1893-1912. Second reprint 1925. (b) A complete and unabridged edition of Vols. 1, 2, 3 with a critical and historical introduction by E. Weber, was published by Dover, New York, 1950. (c) "Maxwell's equations" as we know them today were first expressed by Oliver Heaviside in Phil. Mag., Feb 1888, after Maxwell was already deceased. Indeed, in the 1880s Heaviside formulated the modern vector calculus notion, including the gradient, divergence and curl of a vector.
54. Today's algebra of vectors and vector analysis were first set forth in 1881 in notes made by Professor J. Willard Gibbs at Yale University, for his students. The notes

were widely circulated to scholars in the United States, Britain, and Europe. They were assembled by one of Gibbs' graduate students, Edwin B. Wilson, and eventually published as Vector Analysis, 1901. Particularly see The Scientific Papers of J. Willard Gibbs, Vol. 2: Dynamics, Vector Analysis, Multiple Algebra, Electromagnetic Theory of Light.

55. Heinrich Hertz, Die Fortschritte der Physik, **34**, 1878, pp. 718, 739, 745-755, 758-761, 777f., 830-833; — *ibid.*, **35**, 1879, pp. 779-784, 788f., 792-805; — *ibid.*, **36**, 1880, parts 1 and 2, pp. 765-767, 839-847; — *ibid.*, **37**, 1881, parts 1 and 2, pp. 869-901, 1005-1009; — *ibid.*, **38**, 1882, part 2, pp. 435-439, 447-462, 638-642; — *ibid.*, **39**, 1883, part 2, pp. 503-521, 730-740; — Electric Waves, preface by Lord Kelvin, Dover Publications, New York, 1962 (translation of Hertz 1894, first published in 1893.).
56. M. J. Crowe, A History of Vector Analysis: The Evolution of the Idea of a Vectorial System, University of Notre Dame Press, Notre Dame, Indiana, 1967; also corrected edition, Dover, New York, 1985 gives the history of this “debate” that was not much of a debate, but instead was a straightforward discarding of quaternion electrodynamics.
57. Tait worked out much of the early physics applications in terms of quaternions, and published texts on the mathematics of quaternions. When Hamilton (the founder of quaternions) died in 1865, Tait became the major advocate and prime mover in applying quaternions in physics. He also authored mathematical texts in quaternions. See (a) Peter Guthrie Tait, Elementary Treatise on Quaternions, 1867; (b) — Introduction to Quaternions, 1873. Tait also engaged in a long, acrimonious argument with Heaviside and Gibbs, arguing against their vector methods, and lost in the sharp 1890s debate that settled upon vector electrodynamics as the standard and discarded quaternions.
58. In a letter to William Thomson in 1871, Maxwell had this to say of Tait's work: “You should let the world know that the true source of mathematical methods as applicable to physics is to be found in the Proceedings of the Royal Society of Edinburgh. The volume- surface- and line- integrals of vectors and quaternions and their properties as in the course of being worked out by Tait is worth all that is going on in other seats of learning.”
59. Tait's commentary on Maxwell's work, following Maxwell's death in 1879, is given in P. G. Tait, “Maxwell's scientific work”, Nature, Vol. 21, 5 Feb. 1880, p. 317-321.
60. For Lorentz's symmetrical re-gauging of the Maxwell-Heaviside equations, see J. D. Jackson, Classical Electrodynamics, 3rd Edn., John Wiley and Sons, New York, 1999. For the vacuum, Maxwell's equations reduce to two coupled equations, shown as equations 6.10 and 6.11 on p. 246. The Lorentz re-gauging condition is applied by Jackson on p. 240, resulting in two inhomogeneous wave equations given as equations 6.15 and 6.16. The Lorentz condition is given in equation 6.14 on p. 240. In short, the curvature of local spacetime and the local active vacuum have been deterministically structured so that they produce the two extra equal but antiparallel forces. So all excess energy received by the re-gauged Maxwellian system from the vacuum/spacetime environment is deliberately tied up as internal stress in the system. To gain simpler equations easier to solve, extra free re-gauging field energy of the system has been introduced deliberately from the environment, but only to create

internal stress potential energy, which curves the local spacetime and also alters the local vacuum, *but cannot be used to translate electrons as current and perform useful work in the external load.*

61. Ludvig Valentin Lorenz, "Mémoire sur la théorie de l'élasticité des corps homogènes à élasticité constante," J. Math. (Crelle's Journal), Vol. 58, 1861, p. 329-351.
62. J. D. Jackson and L. B. Okun, "Historical roots of gauge invariance," Rev. Modern Phys., Vol. 73, July 2001, p. 663-680.
63. Oliver Heaviside, "Electromagnetic Induction and Its Propagation," The Electrician, 1885, 1886, 1887, and later. A series of 47 sections, published section by section in numerous issues of The Electrician during 1885, 1886, and 1887.
64. Oliver Heaviside, "On the Forces, Stresses, and Fluxes of Energy in the Electromagnetic Field," Phil. Trans. Roy. Soc. London, 183A, 1893, p. 423-480.
65. J. H. Poynting, "On the transfer of energy in the electromagnetic field," Phil. Trans. Roy. Soc. London, Vol. 175, Part I, 1884, p. 343-361; "On the Connection Between Electric Current and the Electric and Magnetic Inductions in the Surrounding Field," *ibid.*, Vol. 176, 1885, p. 277-306.
66. Mark A. Heald, "Electric fields and charges in elementary circuits," Am. J. Phys. 52(6), June 1984, p. 524.
67. What actually happens is that the intensity of the energy flow at an electron is a measure of the change in the intensity of the vacuum's virtual particle flux there. Hence a more active vacuum interacts more vigorously with the interacting electron, so that the electron thereby extracts and emits additional EM energy, forming an increase in the "local EM field" for which that electron is one of the associated sources. *All EM fields and potentials in a circuit come directly from the local vacuum's activity with local source charges in that circuit. They do not come from cranking the shaft of the external generator or dissipating some chemical energy in the external battery.*
68. In the standard closed current loop circuit, as current is driven from the positive side of the circuit to the ground side, it is also driven back up through the power source's back emf, scattering the charges of that source's dipolarity between its terminals. Scattering the primary source dipole reduces the overall dipolarity of the circuit, and cuts off the dipolarity extraction of EM energy from the local vacuum. In turn, this reduces the additional activity of the local vacuum (its broken symmetry) because the local vacuum potential intensity has been reduced. Hence, this process is said to "dissipate" the collected energy in the circuit. What is actually dissipated is the excess activity of the local vacuum, so that the extra energy pouring from the active circuit dipolarity is reduced.
69. H. J. Josephs, "The Heaviside papers found at Paignton in 1957," IEE Monograph No. 319, Jan. 1959, p. 70-76. These were Heaviside's hand-written notes found beneath the floorboards in his little garret apartment, after his death.
70. E. R. Laithwaite, "Oliver Heaviside – establishment shaker," Electrical Review, 211(16), Nov. 12, 1982, p. 44-45.

71. See (a) H. A. Lorentz, Vorlesungen über Theoretische Physik an der Universität Leiden, Vol. V, Die Maxwell'sche Theorie (1900-1902), Akademische Verlagsgesellschaft M.B.H., Leipzig, 1931, "Die Energie im elektromagnetischen Feld," p. 179-186. Figure 25 on p. 185 shows the Lorentz concept of integrating the Poynting vector around a closed cylindrical surface surrounding a volumetric element. This is the procedure which arbitrarily selects only a small component of the energy flow associated with a circuit—specifically, the small Poynting component being diverged into the circuit to power it—and then treats that tiny component as if it were the "entire" energy flow. Thereby Lorentz arbitrarily discarded the extra Heaviside circuital energy transport component that is usually not diverged into the circuit conductors at all, does not interact with anything locally, and is just wasted. It must be strongly stressed that the computed Poynting vector is not the total flow of EM energy through a unit plane at right angles to the flow direction, contrary to usual interpretations. This is confirmed by leading electrodynamicists. E.g., see (b) Wolfgang K.H. Panofsky and Melba Phillips: Classical Electricity and Magnetism, Second Edition, Addison-Wesley, Menlo Park, CA, 1962, third printing 1969, p. 180. Quoting: "*Paradoxical results may be obtained if one tries to identify the Poynting vector with the energy flow per unit area at any point.*"
72. E.g., see J. D. Jackson, Classical Electrodynamics, 2nd edition, Wiley, 1975, p. 237. Quoting: "...the Poynting vector is arbitrary to the extent that the curl of any vector field can be added to it. Such an added term can, however, have no physical consequences." Our comment is that the statement is approximately true only in a flat local spacetime. It is not true at all in a curved local spacetime.
73. (a) Craig F. Bohren, "How can a particle absorb more than the light incident on it?" Am. J. Phys., 51(4), Apr. 1983, p. 323-327. Under nonlinear conditions, a particle can absorb more energy than is in the [Poynting component of the] light incident on it. Metallic particles at ultraviolet frequencies are one class of such particles and insulating particles at infrared frequencies are another. See also (b) H. Paul and R. Fischer, {Comment on "How can a particle absorb more than the light incident on it?,"} Am. J. Phys., 51(4), Apr. 1983, p. 327. The repeatable Bohren experiment produces COP = 18.
74. (a) Charles Seife, "Breakthrough: Illuminating the Dark Universe," Science, Vol. 302, Dec. 19, 2003, p. 2038-2039; (b) Stephen Battersby, "The universe gives up its dark secrets," NewScientist, 20/27 Dec. 2003/3 Jan. 2004, p. 16.
75. For a brief biography of Albert Michelson and a reprint of the original paper describing the Michelson-Morley experiment, see "Albert Abraham Michelson," in Selected Papers of Great American Physicists, S. Weart, editor, AIP: New York, 1976, pp. 63- 80.
76. E.g., Feynman says it this way: "...in dealing with force the tacit assumption is always made that the force is equal to zero unless some physical body is present... One of the most important characteristics of force is that it has a material origin..." Richard P. Feynman, Robert B. Leighton, and Matthew Sands, The Feynman Lectures on Physics, Addison-Wesley, Reading, MA, Vol. 1, 1964, p. 12-2.
77. Jackson—a superb electrodynamicist whom we greatly admire—shows how classical electrodynamicists just arbitrarily avoid the problem. Quoting: "*Most clas-*

*sical electrodynamicists continue to adhere to the notion that the EM force field exists as such in the vacuum, but do admit that physically measurable quantities such as force somehow involve the product of charge and field.*" J. D. Jackson, Classical Electrodynamics, Wiley, NY, 2nd edition, p. 249. Carefully note that Jackson at least does state the problem and how it is usually handled.

78. As a direct example of the novel and unusual actions generated by negative energy charging, the electrolyte can be poured out of a lead acid battery and the battery filled with distilled water. In that condition it can still be "charged up" with negative energy using the processes of this invention, and it will furnish electrical power in that condition, though not as strongly as with the electrolyte. An approach for this highly unusual behavior can be gleaned from quantum field theory, where there are four photon polarizations (see Lewis H. Ryder, Quantum Field Theory, Second Edition, Cambridge University Press, 1996, p. 147+). With the photon velocity vector along the z-axis by convention, x- or y-polarization gives the well-known "transverse" photon. If the photon energy is vibrating to and fro along the line of motion (along the z-axis), that is a longitudinally polarized photon, or just the "longitudinal photon". If the energy is vibrating to and fro along the t-axis, it has no polarization vector in 3-space but only on the fourth axis, t. Hence, that is the time-polarized or "scalar" photon ("scalar" meaning no polarization vector in any of the three spatial dimensions). Neither the longitudinal photon nor the scalar photon is *individually* observable. However, the combination of the two is observed as the instantaneous scalar potential—as common voltage. Thus, "voltage" of a battery involves and is comprised of not only energy oscillations in 3-space along the line of motion of the photon, but also of energy oscillations in the time domain. With a wrench away from the hoary old classical concept, this means that to build up a voltage in a battery or capacitor (recharge it) is to build up and maintain sets of oscillating EM energy waves in both the time domain and along the line of motion of photons.

In short, "charging" a battery or capacitor involves not only 3-space energy charging, but also time-domain energy charging. Such "time charging" is completely outside the EPE model, and totally unaccounted in classical EM theory and practice. Negative energy potential (negative energy voltage), then, involves not only "spatial" reversal, but also temporal reversal on the time axis. Hence the reversal of corrosive chemical actions that have previously occurred. *In the very limited sense being referred to here, rapid negative energy recharging of the battery also involves rapid reversal of many deleterious spatial-energetic effects that previously occurred in forward time.*





## Table of Figures

Figure 1. Recharging a Battery from a Generator	15
Figure 2. Ringing of Ions in the Battery from a Hammer Effect	17
Figure 3. Circuit for the Bedini Free Energy Device	19
Figure 4. Oscilloscope Wave Form	20
Figure 5. Stimulated Resonance Provides Self-Charging	21
Figure 6. Output Pulses from a D.C. Generator	23
Figure 7. Expanded Output from a D.C. Generator	23
Figure 8. A.C. Generator Output	24
Figure 9. Rectified Output from an A.C. Generator	24
Figure 10. Variation of a Rectified A.C. Generator	25
Figure 11. Conventional Explanation	25
Figure 12. Split Commutator	26
Figure 13. Split Commutator with 3 Brushes	27
Figure 14. Prototype Hookup	28
Figure 15. Prototype of Free Energy Unit	31
Figure 16a. Bedini's Test Model No. 2	32
Figure 16b. Bedini's Test Model No. 2 (Controller)	33
Figure 17. The Supersystem	37
Figure 18. Electrical Engineering Excludes the Supersystem and its Component Interactions	38
Figure 19. Operation of the Normal Electrical Power System	38
Figure 20. Operation of the Solar Powered Electrical Power System	39
Figure 21. Two-Reservoir Representation of the Common Heat Pump	39
Figure 22. Operation of the Invention in $1.0 < COP < \infty$ Mode	40
Figure 23. Operation of the Invention in $COP = \bullet$ Mode	40
Figure 24. Mechanism for amplification of negative energy flow in impedance Sections, for Sharp Gradients	41
Figure 25. Typical Circuit Elements that Have Impedance and Exhibit Amplification of Negative Energy Flow, for Sharp Gradients	41
Figure 26. Inductance-Coupled Impedance-Matching Trigger Device	42
Figure 27. Pulse Outputs from the Oscillator-Trigger Unit	42
Figure 28 Free Running 555 Timing Circuit	43

Figure 29. High Voltage Switching, E-Amplification, and Battery Charging Operation	43
Figure 30. High Voltage Switching across the Battery in Floating Ground Situation	44
Figure 31. Scheme for Battery Charging from an Environmental High Voltage Source	44
Figure 32. External Elevated Antenna for Negative Energy Charging of Batteries	45
Figure 33. Full Diagram of the Radiant Energy Charger Using an SCR	46
Figure 34. Radiant Energy Powering of the Monopole Motor	47
Figure 35. Using Earth Cells with the Potential Switch and a Transistor	48
Figure 36. The Invention Shown as an Inverted Potential Switch	49



Publisher for the Tom Bearden website

[www.cheniere.org](http://www.cheniere.org)

**Books by Tom Bearden**

*Energy from the Vacuum: Concepts and Principles*

*The Final Secret of Free Energy*

*Oblivion: America at the Brink*

*Fer de Lance: Briefing on Soviet Scalar Electromagnetic Weapons*

*Excalibur Briefing: Explaining Paranormal Phenomena*

*Gravitobiology: A New Biophysics*

*AIDS: Biological Warfare*

**DVDs**

*Tom Talks Tesla*

*Floyd Sweet's Secrets*

*Radionics: Action at a Distance*

*Tesla's Secret and the Soviet Tesla Weapons*

*Soviet Weather Engineering over North America*

*Secret Superweapons that Drive Disarmament Negotiations*

*AIDS as Biological Warfare: A Possible Electromagnetic Solution*

**Also from Cheniere Press**

*The Secret Life of Magnets* by Howard Johnson

20 Bedini-Bearden Years  
**FREE ENERGY GENERATION**  
Circuits & Schematics

Lt. Col. Thomas E. Bearden  
(U.S. Army, Retired)

John Bedini



This book celebrates the twenty-year collaboration of energy activist John Bedini with conceptualist Tom Bearden, whose creative forces have been focused towards bringing a marketable, engineered, free-energy solution to publics throughout the world. *Free Energy Generation* contains the ideation, theory and their latest joint patent for the generation of this energy from the vacuum.

John Bedini contributed to the "free energy" movement of the 1970s and early 1980s, experimenting with a variety of devices while running his audio electronics business. After publishing plans for the construction of an energy device that was demonstrated at the 1984 Bicentennial Tesla symposium, Bedini went on to develop the more sophisticated circuitry that is currently in use by him today.

Nuclear engineer Lt. Col. Thomas E. Bearden (U.S. Army, Retired) is the author of numerous books, papers, briefings and presentations dealing with anomalous phenomena, scalar electromagnetics and free energy devices. Bearden was a member of Mensa, Society for the Investigation of the American Physics Teachers, the Air Force Association, the Association of the U.S. Army, The American Nuclear Society, and the American Defense Preparedness Association. He is currently the Director of the Association of Distinguished American Scientists (ADAS) and is CEO of CTEC, Inc.

ISBN 0-9725146-0-6

CHEMIERE  
  
PRESS

see package with video copy